



TASK 30

STANDARDS/ GUIDELINES



WAYFINDING SIGNAGE MASTER PLAN

VOLUME 50 GROUND TRANSPORTATION

PROJECT N° FC5801 - C / #7

 **Hartsfield-Jackson**
Atlanta International Airport®

Prepared by:  **AIS** |  **VALANCOURT**
INTERNATIONAL, LLC

1.0

GRAPHIC STANDARDS

VOLUME **50** GROUND TRANSPORTATION

- 11 Typography
- 12 Terminology/Symbology
- 13 Message Hierarchy
- 14 Arrow Standards
- 15 Color Standards



1.0 GRAPHIC STANDARDS

- 1.1 Typography 1-01
 - Line Spacing 1-02
- 1.2 Terminology / Symbology
 - Principal Facilities 1-03
 - Fundamental Functions 1-04
 - Specialty Icons - Primary Identification 1-05
- 1.3 Message Hierarchy
 - Message Function 1-06
 - Message Hierarchy Examples 1-07
- 1.4 Arrow Standards 1-08
- 1.5 Color Standards
 - Color Specifications 1-09
 - Color Applications – Primary Identification 1-10

#	REVISION	DATE
1	Updated	07/25/17
2	Updated	10/13/17

ABCDEFGHIJKLMNOPQRSTUVWXYZ
 abcdefghijklmnopqrstuvwxyz
 0123456789@#%^&*()::

Gotham Book

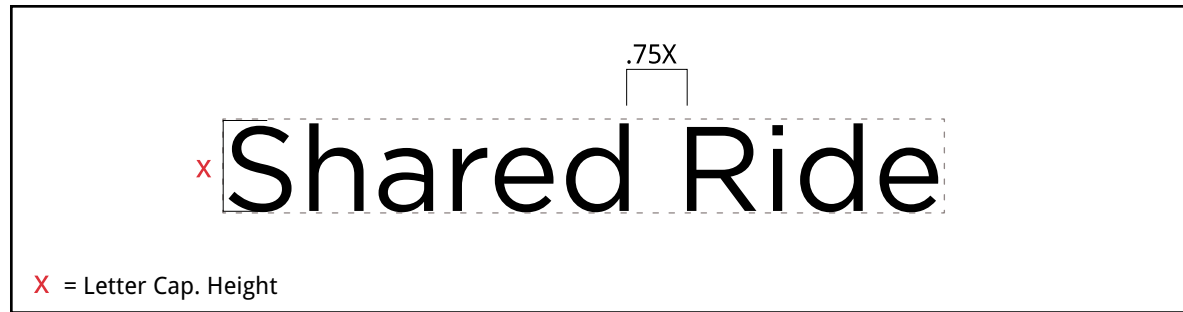

Letter Spacing Correct - Kerning at "- 49 Points"

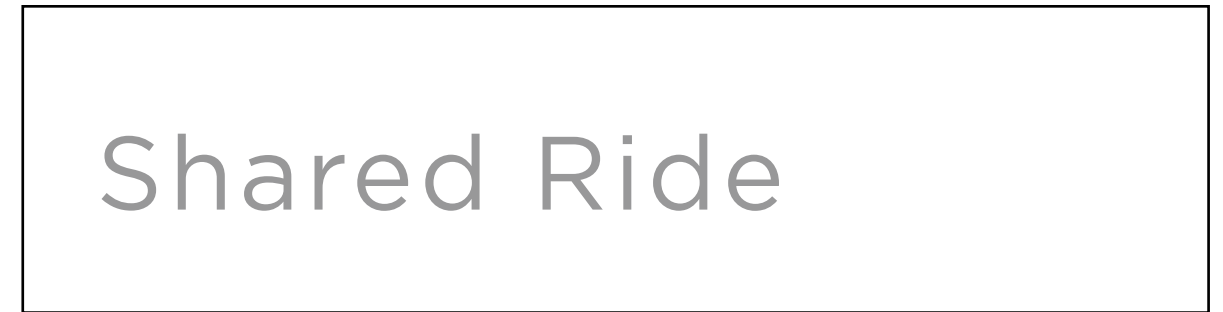

Letter Spacing Too Wide



Letter Spacing Too Close

#	REVISION	DATE
1	Updated	07/25/17
2	Updated	10/13/17

Line Spacing

Shared Ride
Spanish Translation

Taxi
Spanish Translation

ALIGNED

Line Spacing Examples

2x

1.5x

Shared Ride

Spanish Translation

CENTER ALIGN

Spacing Example between arrow, symbol and messages

Off-Airport
Parking

Taxi

ALIGNED

RELATED LINES OF TEXT

UNRELATED LINES OF TEXT

Unrelated Line Spacing Examples

Principal Facilities

#	REVISION	DATE
1	Updated	07/25/17
2	Updated	10/13/17

TERMINOLOGY

SYMBOL

INTERIOR APPLICATIONS

Terminal North



· Identifies Terminal North

Terminal South



· Identifies Terminal South

Domestic Terminal



· Identifies Domestic Terminal

International Terminal



· Identifies International Terminal



Fundamental Functions

#	REVISION	DATE
1	Updated	07/25/17
2	Updated	10/13/17

TERMINOLOGY

SYMBOL

EXTERIOR APPLICATIONS

Taxi



· Identifies portion of Ground Transportation that functions as Taxi

Pre - Arranged Pick Up



· Identifies portion of Ground Transportation that functions as Pre-Arranged Pick Up

Shared Ride



· Identifies portion of Ground Transportation that functions as Shared Ride

Hotel



· Identifies portion of Ground Transportation that functions as Hotel

Off - Airport Parking



· Identifies portion of Ground Transportation that functions as Off-Airport Parking

Specialty Icons - Primary Identification

#	REVISION	DATE
1	Updated	07/25/17
2	Updated	10/13/17

TERMINOLOGY

SYMBOL

INTERIOR APPLICATIONS

Ground Transportation



- Identifies Ground Transportation
- Is always used in conjunction with the Ground Transportation
 - Ground Transportation - White on ■ Green (Pantone 3415C)

Taxi



- Identifies Taxi
- Is always used in conjunction with the Ground Transportation
 - Ground Transportation - White on ■ Green (Pantone 3415C)

Pre - Arranged Pick Up



- Identifies Pre-Arranged Pick Up
- Is always used in conjunction with the Ground Transportation
 - Ground Transportation - White on ■ Green (Pantone 3415C)

Shared Ride



- Identifies Shared Ride
- Is always used in conjunction with the Ground Transportation
 - Ground Transportation - White on ■ Green (Pantone 3415C)

Hotel



- Identifies Hotel
- Is always used in conjunction with the Ground Transportation
 - Ground Transportation - White on ■ Green (Pantone 3415C)

Off - Airport Parking



- Identifies Off-Airport Parking
- Is always used in conjunction with the Ground Transportation
 - Ground Transportation - White on ■ Green (Pantone 3415C)

Message Function

#	REVISION	DATE
1	Updated	07/25/17
2	Updated	10/13/17

	PRIMARY	SECONDARY	TERTIARY
Directional	Terminal North Terminal South Domestic Terminal International Terminal Ground Transportation		
Identification	Terminal North Terminal South International Terminal Ground Transportation	Taxi Pre - Arranged Pick Up International Terminal Shared Ride Hotel Off - Airport Parking <i>(Airline Names)</i>	
Information	<i>(Ground Transportation Directory)</i>		
Regulatory or Safety	Do Not Enter		

#	REVISION	DATE
1	Updated	07/25/17
2	Updated	10/13/17

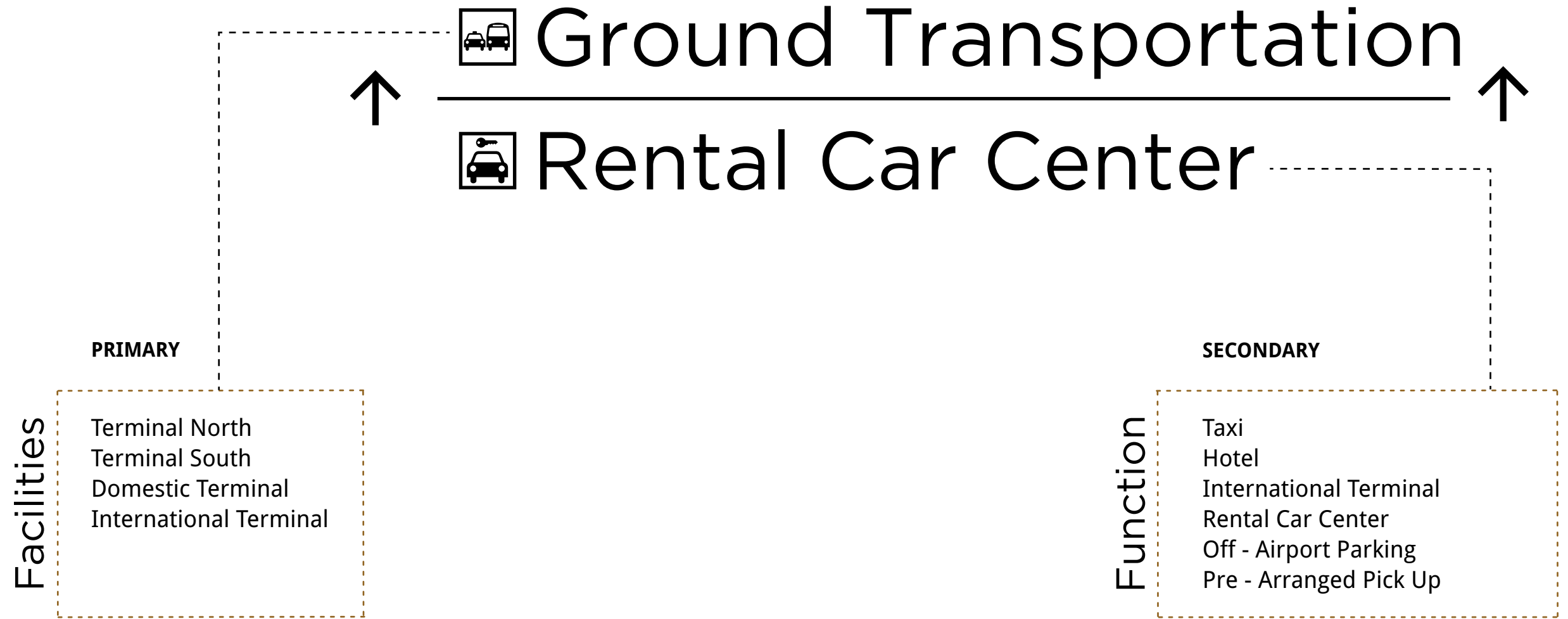

Ground Transportation Message Hierarchy Example
SCALE: NTS

1.0 GRAPHIC STANDARDS

1.4 Arrow Standards

#	REVISION	DATE
1	Updated	07/25/17
2	Updated	10/13/17

These figures define the arrow orientations and size that shall be used throughout Ground Transportation.

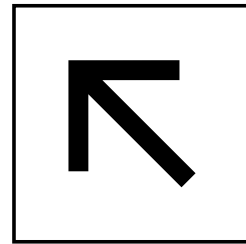

Up to the Left
10 o'clock

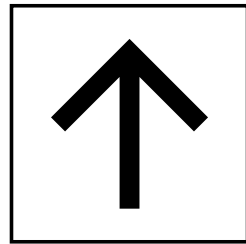

Up and/or Straight
Ahead / 12 o'clock

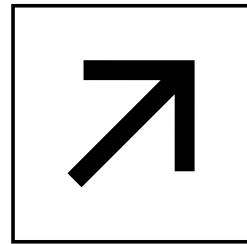

Up to the Right
2 o'clock

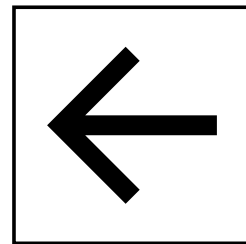

To the left
9 o'clock

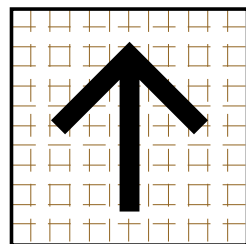

To the Right
3 o'clock

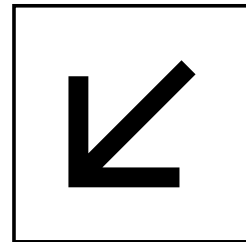
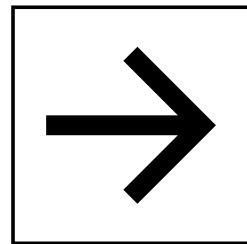

Down to the Left
7 o'clock

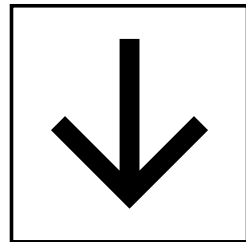

Down
6 o'clock

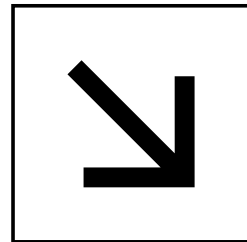

Down to the Right
5 o'clock

Arrows Orientation
SCALE: NTS

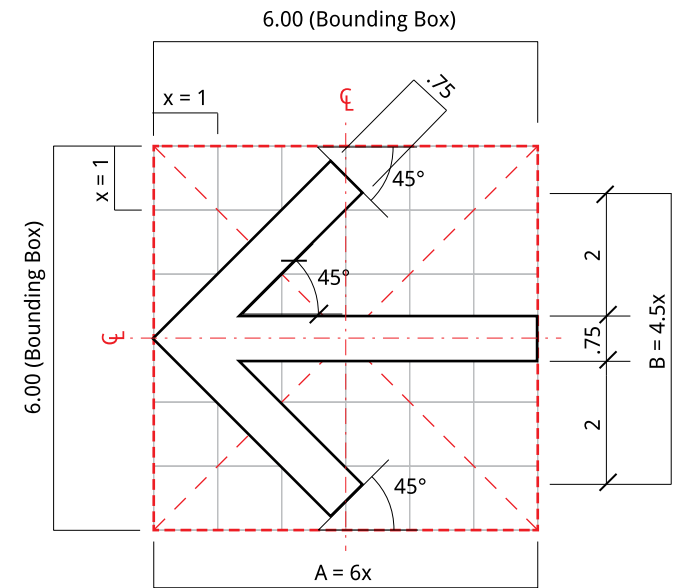

Straight Arrow:
Use for arrows angled at: 0°, 90°, 180°, 270°

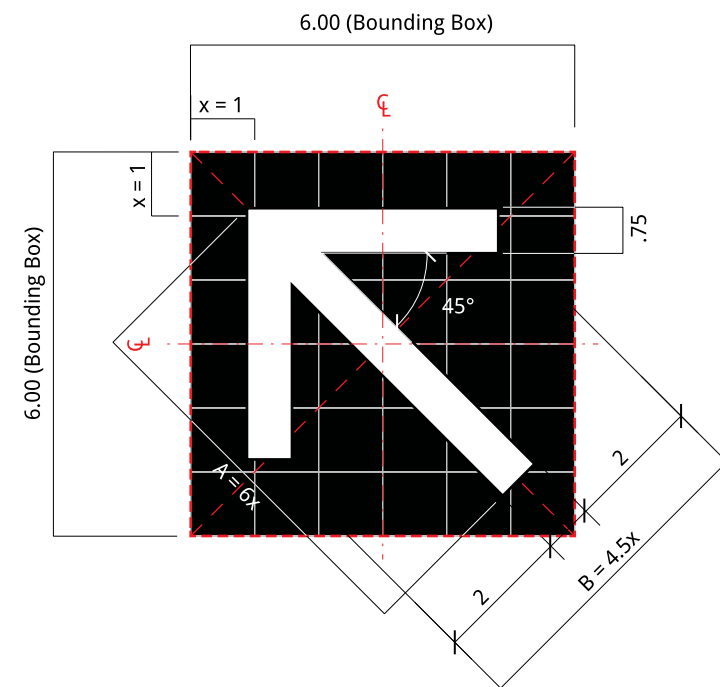

Angled Arrow:
Use for arrows angled at: 45°, 135°, 225°, 315°





Arrows Sizes
SCALE: NTS

Color Specifications

#	REVISION	DATE
1	Updated	07/25/17
2	Updated	10/13/17

This section of the document shall specify colors and applications that are to be used in the Ground Transportation.

**or approved equal*

COLOR APPLICATION	COLOR	PANTONE Equivalent	MATERIAL Equivalent
Functional Area Symbol	N/A	N/A	 Satin Brushed Aluminum
Sign Panel	N/A	N/A	 Satin Brushed Aluminum
Ground Transportation Identification	Green	 Pantone 3415C	Exterior Sign Grade Translucent Polycarbonate
Arrow	White	White	Exterior Sign Grade Translucent Polycarbonate
Symbol	White	White	Exterior Sign Grade Translucent Polycarbonate
Background	Black	 Process Black	Exterior Sign Grade Translucent Polycarbonate
English Text	White	White	Exterior Sign Grade Translucent Polycarbonate
Translation Text	White	White	Exterior Sign Grade Translucent Polycarbonate

Note: Color palette should not be substituted / replaced.

Color Applications - Primary Identification

#	REVISION	DATE
1	Updated	07/25/17
2	Updated	10/13/17

Sign Finishes

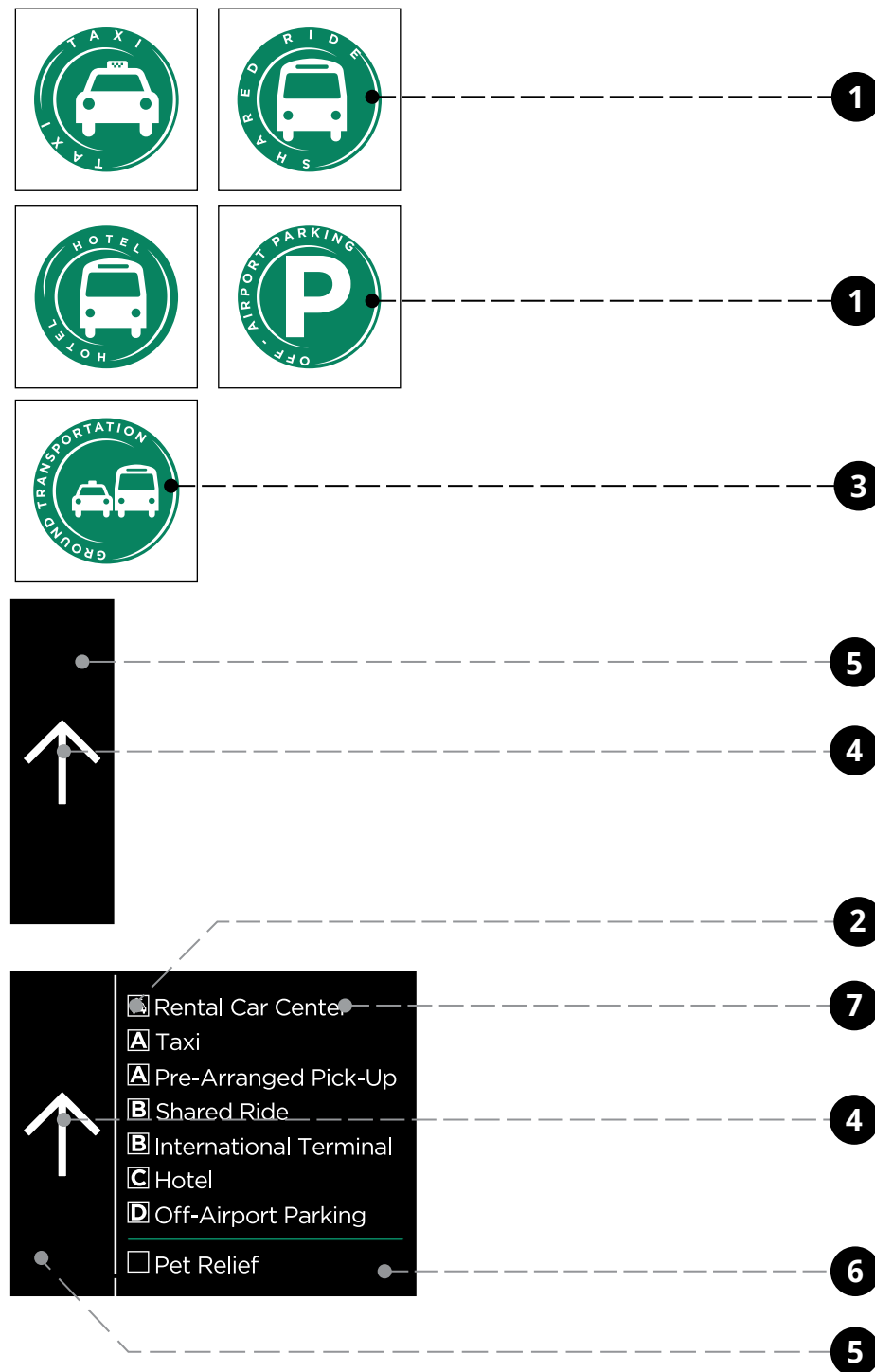

Color Application Examples
SCALE: NTS
Note: Color palette should not be substituted / replaced.

Sign Color Application

COLOR APPLICATION	COLOR
1 Ground Transportation Function Symbol	Pantone 3415C
2 Aisle Identification	Internally Illuminated
3 Ground Transportation Identification	Pantone 3415C
4 Arrow	White
5 Arrow panel	Process Black
6 Background	Process Black
7 English Text	White

2.0

**SIGN TYPES GROUND -
TRANSPORTATION**

VOLUME **50** GROUND TRANSPORTATION

- 2.1 Sign Type Series Number
- 2.2 Sign Type Identification System
- 2.3 Sign Type Index
- 2.4 Sign Type Layouts

2.0 SIGN TYPES

2.1 Sign Type Series Numbers 2-01

2.2 Sign Type Identification System 2-02

2.3 Sign Type Index 2-03

2.4 Sign Type Layouts

ST-500 - Primary Directional - Freestanding 2-07

ST-540 - Primary Identification - Canopy Attached 2-08

ST-542 - Primary Identification - Ceiling Mounted (Terminal) 2-09

ST-544 - Primary Identification - Ceiling Mounted (Ground
Transportation) 2-11

ST-550 - Secondary Identification - Soffit Mounted 2-12

ST-560 - Primary Informational - Freestanding 2-13

ST-570 - Secondary Informational - Flag Mounted 2-14

ST-572 - Secondary Informational - Flag Mounted (Dynamic) 2-15

ST-574 - Secondary Informational - Post / Flag Mounted 2-16

ST-576 - Secondary Informational - Freestanding 2-17

2.0 SIGN TYPES

#	REVISION	DATE
1	Updated	07/25/17
2	Updated	10/13/17

2.1 Sign Type Series Numbers

- **100 Series** – Terminals (Domestic / International)
 - 100 - 129 – Primary Directional
 - 130 - 139 – Secondary Directional
 - 140 - 149 – Primary Identification
 - 150 - 159 – Secondary Identification
 - 160 - 169 – Primary Informational
 - 170 - 179 – Secondary Informational

- **200 Series** – Concourses
 - 200 - 229 – Primary Directional
 - 230 - 239 – Secondary Directional
 - 240 - 249 – Primary Identification
 - 250 - 259 – Secondary Identification
 - 260 - 269 – Primary Informational
 - 270 - 279 – Secondary Informational

- **300 Series** – Transportation Malls
 - 300 - 329 – Primary Directional
 - 330 - 339 – Secondary Directional
 - 340 - 349 – Primary Identification
 - 350 - 359 – Secondary Identification
 - 360 - 369 – Primary Informational
 - 370 - 379 – Secondary Informational

- **400 Series** – Curbsides (Domestic / International)
 - 400 - 429 – Primary Directional
 - 430 - 439 – Secondary Directional
 - 440 - 449 – Primary Identification
 - 450 - 459 – Secondary Identification
 - 460 - 469 – Primary Informational
 - 470 - 479 – Secondary Informational

- **500 Series** – Ground Transportation (Domestic / International)
 - 500 - 529 – Primary Directional
 - 530 - 539 – Secondary Directional
 - 540 - 549 – Primary Identification
 - 550 - 559 – Secondary Identification
 - 560 - 569 – Primary Informational
 - 570 - 579 – Secondary Informational

- **600 Series** – Parking (Domestic / International)
 - 600 - 629 – Primary Directional
 - 630 - 639 – Secondary Directional
 - 640 - 649 – Primary Identification
 - 650 - 659 – Secondary Identification
 - 660 - 669 – Primary Informational
 - 670 - 679 – Secondary Informational

- **700 Series** – Roadways (Domestic / International)
 - 700 - 729 – Primary Directional
 - 730 - 739 – Secondary Directional
 - 740 - 749 – Primary Identification
 - 750 - 759 – Secondary Identification
 - 760 - 769 – Primary Informational
 - 770 - 779 – Secondary Informational

#	REVISION	DATE
1	Updated	07/25/17
2	Updated	10/13/17



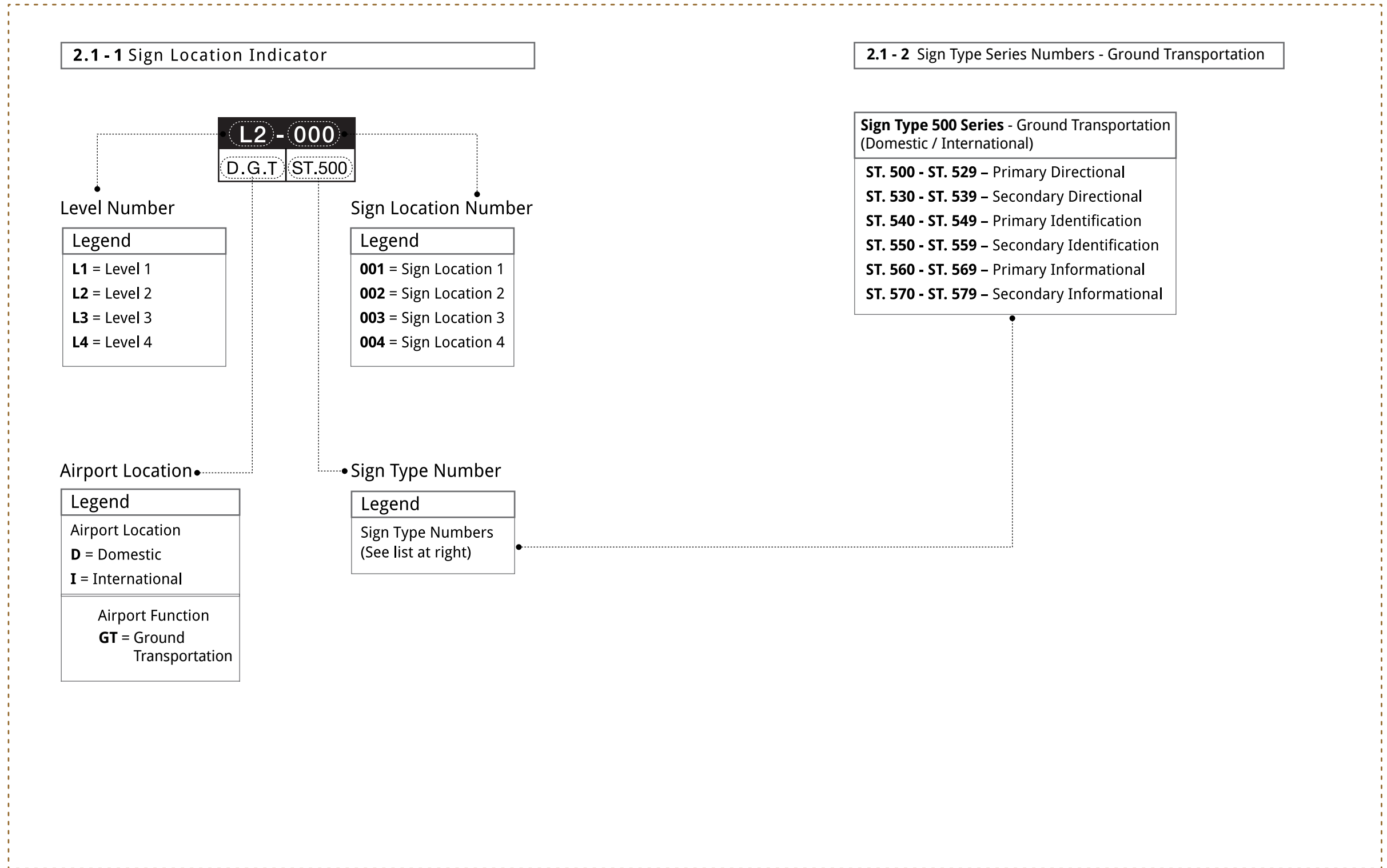

Sign Location Indicator - Ground Transportation

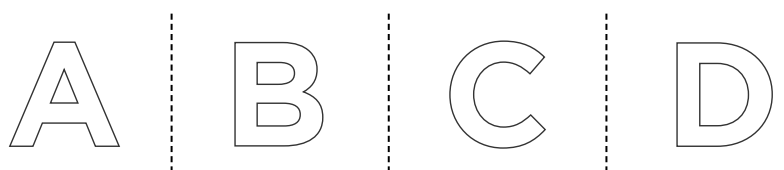

2.0 SIGN TYPES

#	REVISION	DATE
1	Updated	07/25/17
2	Updated	10/11/17

2.3 Sign Type Index

ST - 500 Primary Directional		
N/A	N/A	<p>Ground Transportation</p> 
N/A	N/A	<ul style="list-style-type: none"> - Freestanding / 2 Sided / 1 Directional - Overall dimensions: 8' - 6" H x 2' - 3" W x 6" D - Provides Primary Directional Information - For use in Ground Transportation only : Accent Color Green - Pantone 3415 C
ST - 540 Primary Identification		
N/A	N/A	<p>Ground Transportation</p> 
N/A	N/A	<ul style="list-style-type: none"> - Canopy Attached / 1 Sided / 1 Level of Messaging - Overall dimensions: 1' - 6" H x Width Varies x 1" D - Provides Primary Identification - For use in Ground Transportation only : Accent Color Green - Pantone 3415 C
ST-542 Primary Identification (Dynamic)		
Terminal South	Terminal North	Ground Transportation
		
<ul style="list-style-type: none"> - Ceiling Mounted / 1 Sided / 1 Level of Messaging with <u>Dynamic Display Panel</u> - Overall dimensions: 2' - 9" H x 17' - 0" W x 9" D - Provides Primary Identification - For use in Terminal South only : Accent Color Red - Pantone 1795 	<ul style="list-style-type: none"> - Ceiling Mounted / 1 Sided / 1 Level of Messaging with <u>Dynamic Display Panel</u> - Overall dimensions: 2' - 9" H x 17' - 0" W x 9" D - Provides Primary Identification - For use in Terminal North only : Accent Color Blue - Pantone 2935 	<ul style="list-style-type: none"> - Ceiling Mounted / 1 Sided / 1 Level of Messaging with <u>Dynamic Display Panel</u> - Overall dimensions: 2' - 9" H x 17' - 0" W x 9" D - Provides Primary Identification - For use in Ground Transportation only : Accent Color Yellow - Pantone 123

2.0 SIGN TYPES

#	REVISION	DATE
1	Updated	07/25/17
2	Updated	10/13/17

2.3 Sign Type Index

ST - 544 Primary Identification (Dynamic)		
Ground Transportation (Domestic)	Ground Transportation (International)	
		
<ul style="list-style-type: none"> - Ceiling Mounted / 1 Sided / 1 Level of Messaging with Dynamic Display Panel - Overall dimensions: 2' - 9" H x 17' - 0" W x 9" D - Provides Primary Identification - For use in Ground Transportation only : Accent Color Green - Pantone 3415 C 	<ul style="list-style-type: none"> - Ceiling Mounted / 1 Sided / 1 Level of Messaging with Dynamic Display Panel - Overall dimensions: 2' - 9" H x 17' - 0" W x 9" D - Provides Primary Identification - For use in Ground Transportation only : Accent Color Green - Pantone 3415 C 	

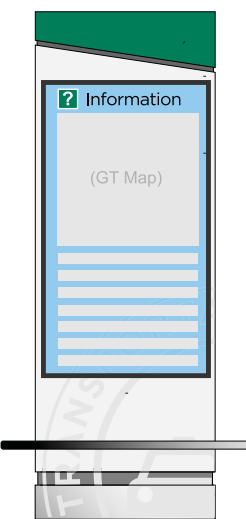

ST - 550 Secondary Identification		
N/A	N/A	Ground Transportation
		
		<ul style="list-style-type: none"> - Soffit Mounted / 1 Sided / 1 Level of messaging - Overall dimensions: 1'-1" H x Field Verify Sign Width x 3" D - Provides Secondary Identification - For use in Ground Transportation only

ST - 560 Primary Informational		
N/A	N/A	Ground Transportation
		
		<ul style="list-style-type: none"> - Freestanding / 2 Sided / 1 Level of Messaging with Dynamic Display Panel - Overall dimensions: 7' - 6" x 2' - 8" W x 6" D - Provides Primary Information - For use in Ground Transportation only : Accent Color Green - Pantone 3415 C

2.0 SIGN TYPES

#	REVISION	DATE
1	Updated	07/25/17
2	Updated	10/13/17

2.3 Sign Type Index

ST - 570 Secondary Informational		
N/A	N/A	Ground Transportation
		
N/A	N/A	<ul style="list-style-type: none"> - Flag Mounted / 1 Sided / 1 Level of Messaging - Overall dimensions: 9" H x 1'-9" W x 3" D - Provides Secondary Information - For use in Ground Transportation only
ST - 572 Secondary Informational (Dynamic)		
N/A	N/A	Ground Transportation
		
N/A	N/A	<ul style="list-style-type: none"> - Flag Mounted / 1 Sided / 1 Level of Messaging <i>Dynamic Display</i> - Overall dimensions: 9" H x 4'-0" W x 3" D - Provides Secondary Information - For use in Ground Transportation only : Accent Color Green - Pantone 3415 C
ST - 574 Secondary Informational		
N/A	N/A	Ground Transportation
		
N/A	N/A	<ul style="list-style-type: none"> - Post/Flag Mounted / 2 Sided / 2 Levels of messaging - Overall dimensions: 8'-8" H x 1'-6" W x 2" D - Provides Secondary Information - For use in Ground Transportation only : Accent Color Green - Pantone 3415 C
N/A	N/A	N/A
N/A	N/A	N/A

2.0 SIGN TYPES

#	REVISION	DATE
1	Updated	07/25/17
2	Updated	10/11/17

2.3 Sign Type Index

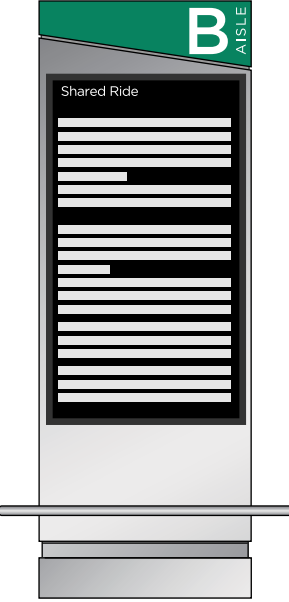
ST - 576 Secondary Informational		
N/A	N/A	Ground Transportation
		
N/A	N/A	<ul style="list-style-type: none"> - Freestanding / 2 Sided / 1 Level of Messaging with Dynamic Display Panel - Overall dimensions: 7' - 6" H x 2' - 8" W x 6" D - Provides Secondary Information - For use in Ground Transportation only : Accent Color Green - Pantone 3415 C

N/A	N/A	N/A
N/A	N/A	N/A

2.0 SIGN TYPES

#	REVISION	DATE
1	Updated	07/25/17
2	Updated	10/13/17

2.4 Sign Type Layouts

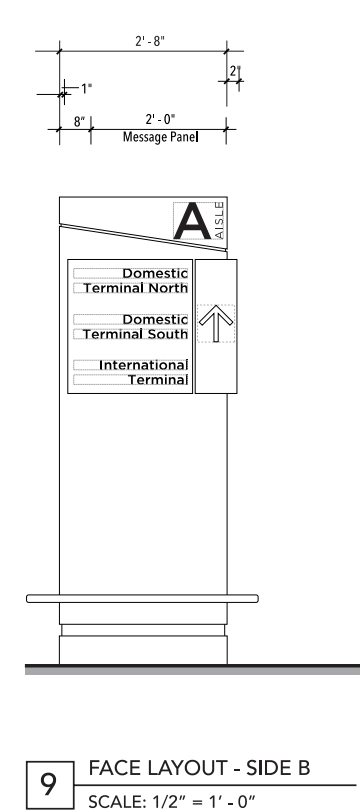
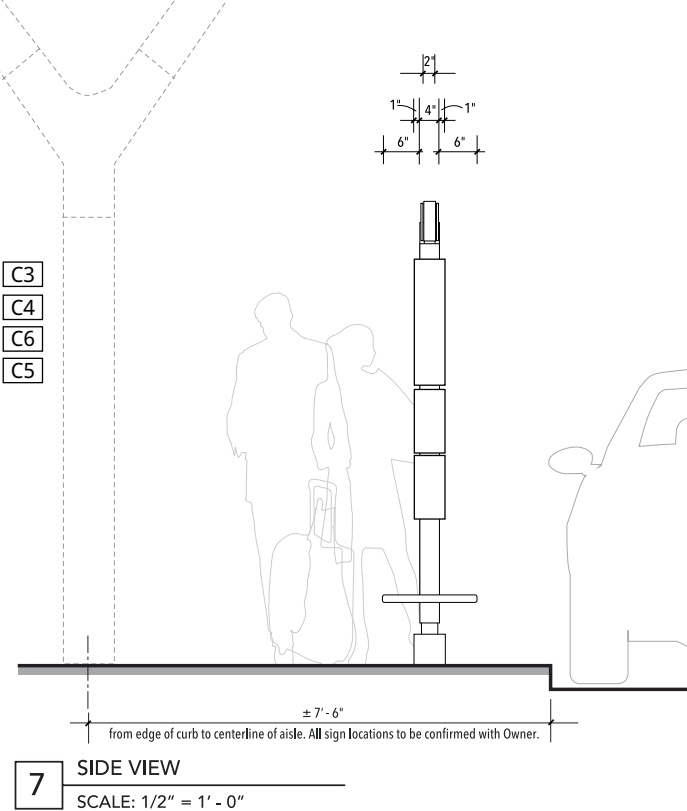
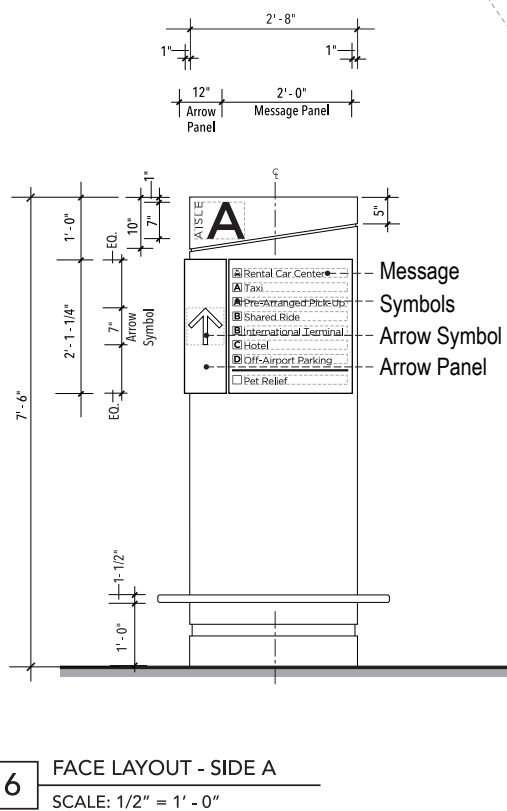
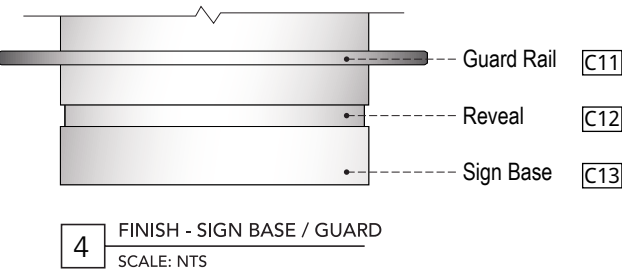
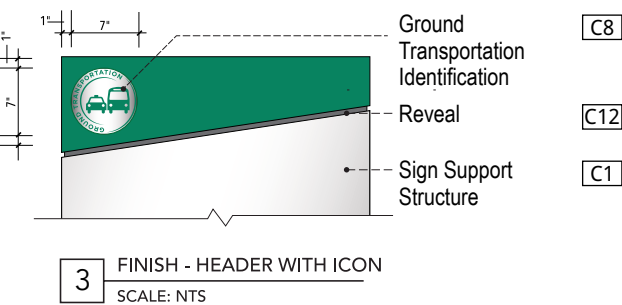
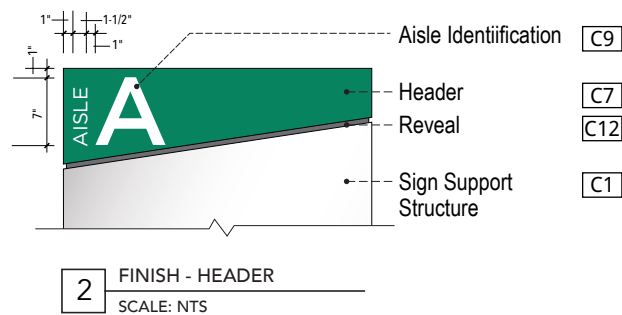
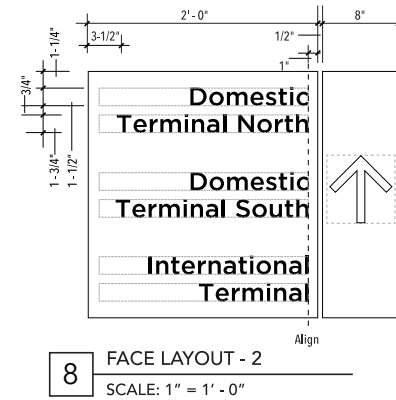
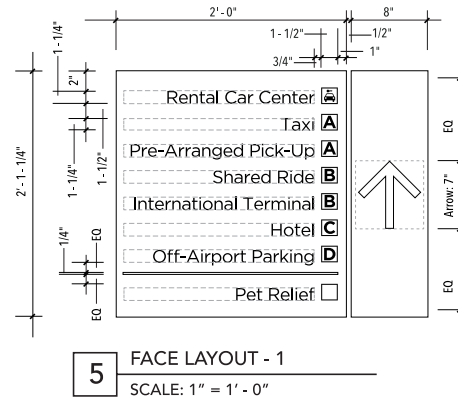
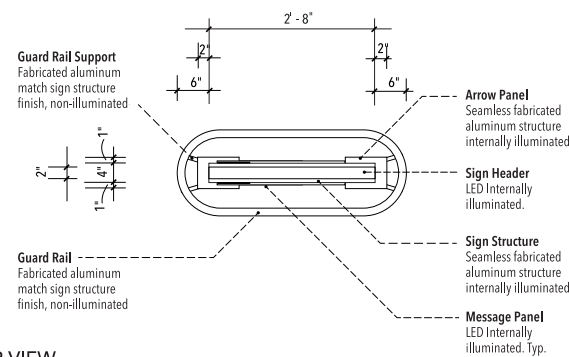

Notes:
1. Signs with directional messages to Ground Transportation will utilize "green" accent bar (Pantone 3415 C) only.
2. Colors are not interchangeable, and cannot be substituted.

Directional ST-500

- Descriptions:** Primary Directional - 2 sided
- Dimensions:** 7' - 6" High x 2' - 8" Wide x 6" Deep
- Location:** Ground Transportation
- Material:** Seamless fabricated aluminum sign
- Lettering:** 1. English - Gotham Book
- Symbology:** Refer to Section 1 - Graphic Standards
- Colors:**
- C1** Sign Support Structure
 - .125" seamless fabricated ALUMINUM with all edges welded, grounded and sanded to a smooth finish.
 - C2** Message Panel
 - .25" Thick fabricated clear acrylic (Exterior Sign Grade Polycarbonate) overlaid matte Black vinyl.
 - LED Internally illuminated.
 - C3** Messages
 - Electronically cut out overlay.
 - LED Internally illuminated.
 - C4** Symbols
 - Electronically cut out overlay.
 - LED Internally illuminated.
 - C5** Arrow Panel
 - .25" Thick fabricated clear acrylic (Exterior Sign Grade Polycarbonate) overlaid matte Black vinyl.
 - LED Internally illuminated.
 - C6** Arrow Symbol
 - Electronically cut out overlay.
 - LED Internally illuminated.
 - C7** Header
 - .125" thick seamless fabricated acrylic corresponding to assigned accent colors for: Ground Transportation - Pantone 3415 C (Green)
 - LED Internally illuminated.
 - C8** Ground Transportation Identification
 - Individual die cut vinyl letters / symbols mounted onto 1/2" thick satin finish aluminum disc.
 - C9** Aisle Identification
 - Electronically cut out overlay.
 - LED Internally illuminated.
 - C10** Fasteners
 - Hidden mechanical fasteners are to be used to attached all sign elements to the sign support structure.
 - C11** Guard Rail
 - Fabricated aluminum match sign structure finish.
 - Non-illuminated.
 - C12** Reveal - Header and Base
 - Satin brushed aluminum.
 - C13** Sign Base
 - Seamless fabricated aluminum structure.
 - Non-illuminated.
- Graphics:** N/A
Mounting: Freestanding
Illuminations: Internal (LED)
Remarks:

2.0 SIGN TYPES

#	REVISION	DATE
1	Updated	07/25/17
2	Updated	10/13/17

2.4 Sign Type Layouts

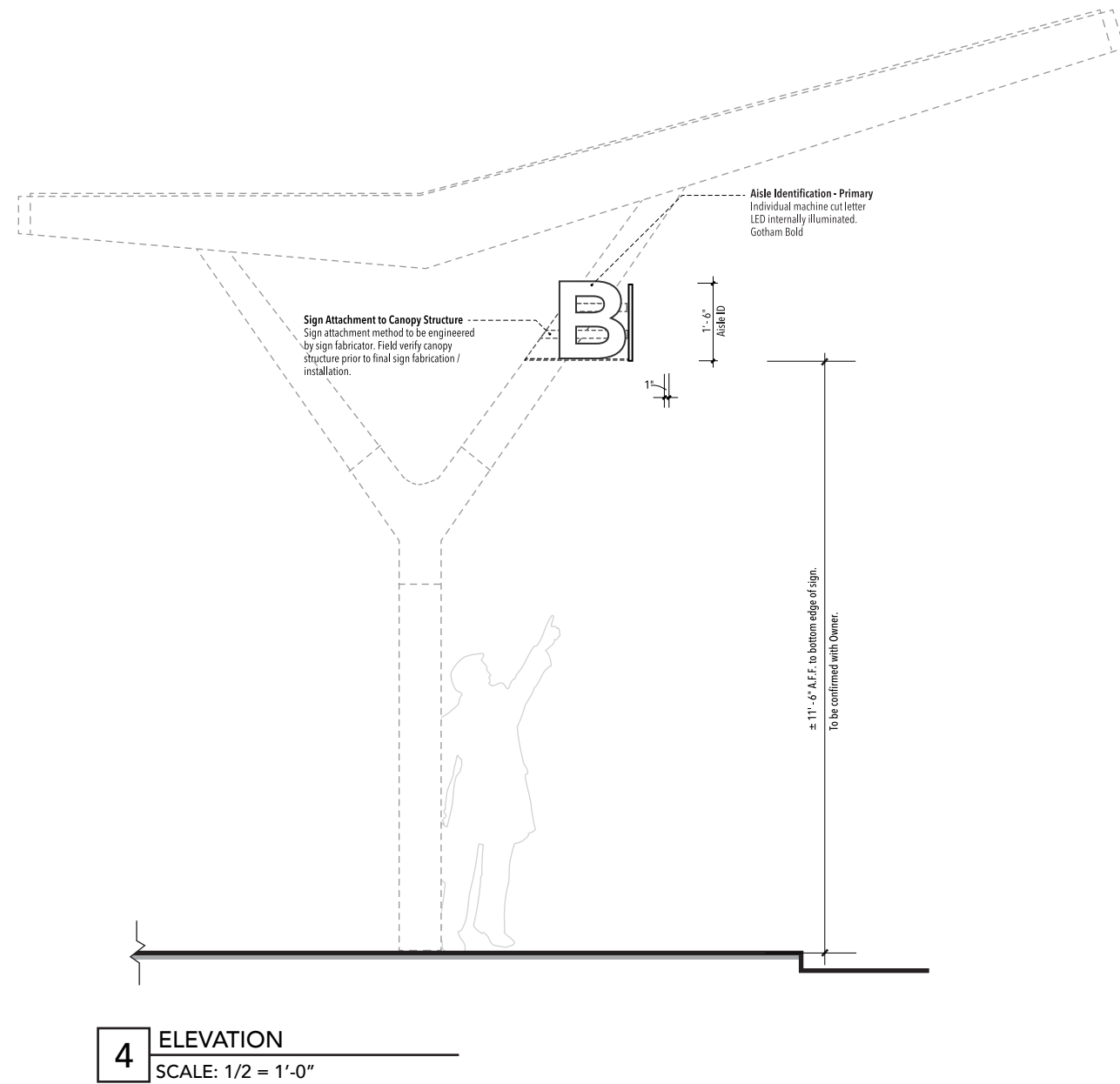
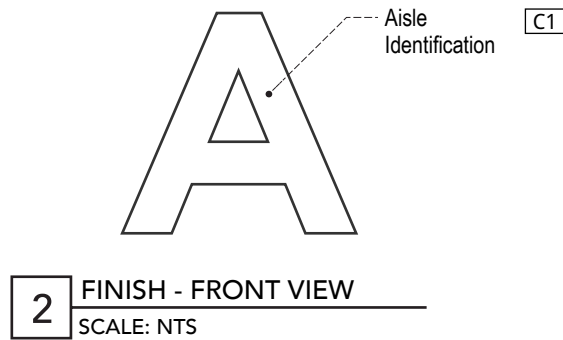
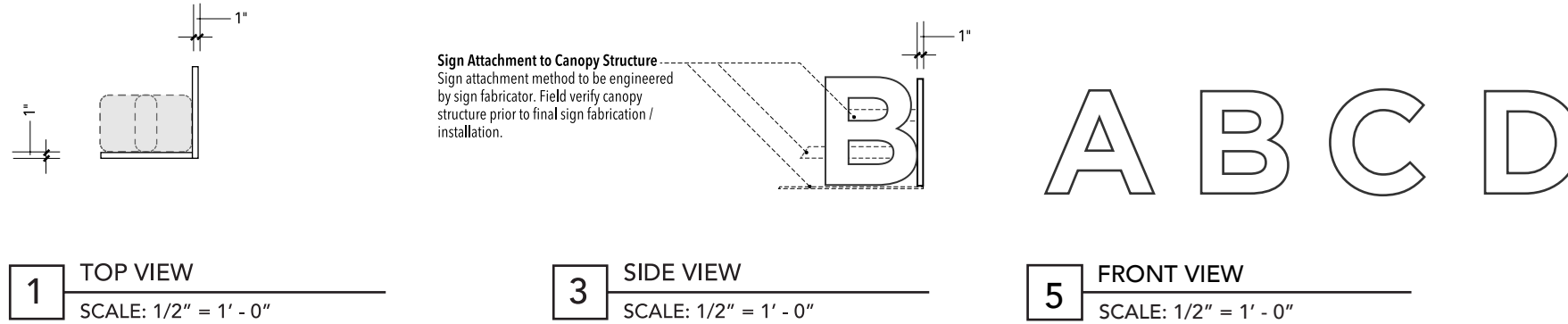

Identification **ST-540**

Descriptions: Primary Identification

Dimensions: 1' - 6" High x 2' - 6" Wide x 1" Deep

Location: Ground Transportation

Material: Seamless fabricated aluminum sign

Lettering: 1. English - Gotham Bold

Symbology: Refer to Section 1 - Graphic Standards

Colors: [C1] Aisle Identification
- Individual machine cut letter.
- LED internally illuminated.

Graphics: N/A

Mounting: Canopy Attached

Illuminations: Internal

Remarks:

2.0 SIGN TYPES

#	REVISION	DATE
1	Updated	07/25/17
2	Updated	10/09/17

2.4 Sign Type Layouts

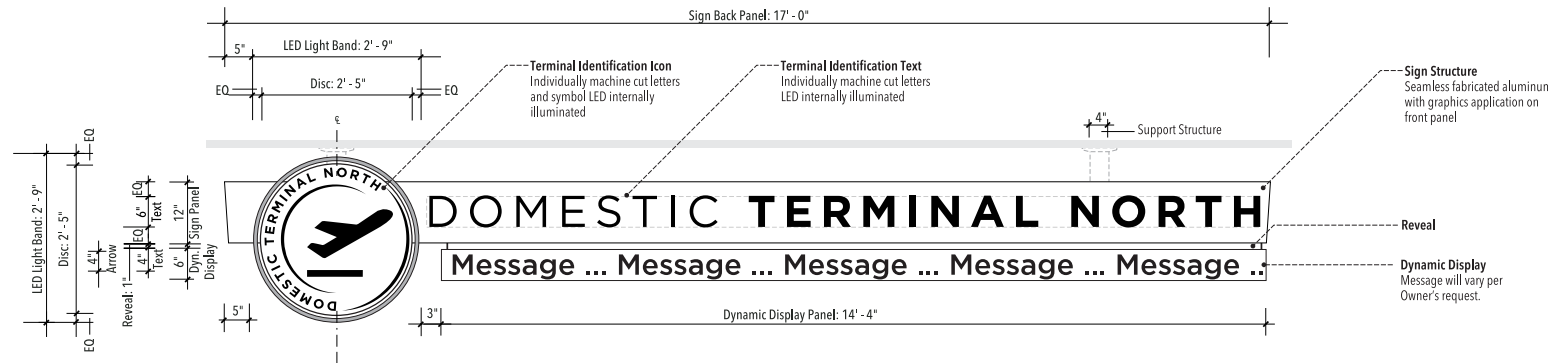

1 FACE LAYOUT - SIDE A
SCALE: 1/2" = 1'-0"

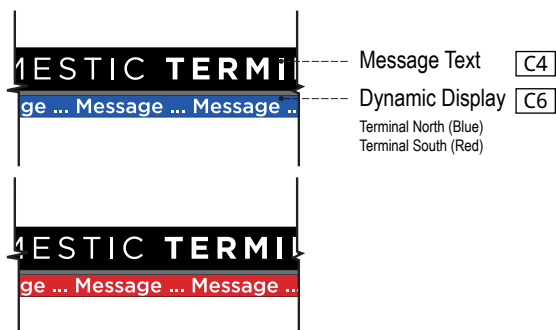

2 SIGN FINISHES
SCALE: NTS

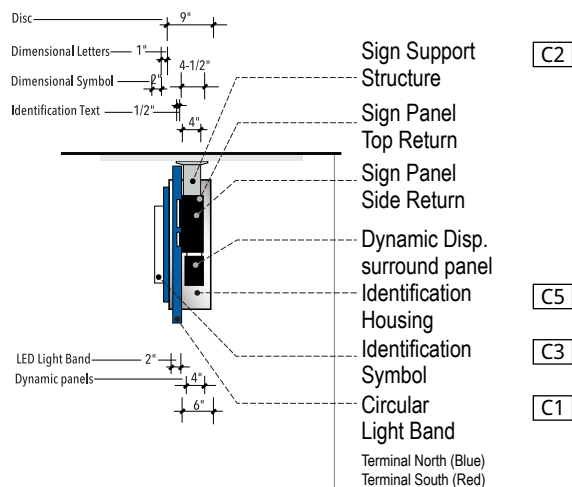

4 SIGN FINISHES - SIDE VIEW
SCALE: NTS

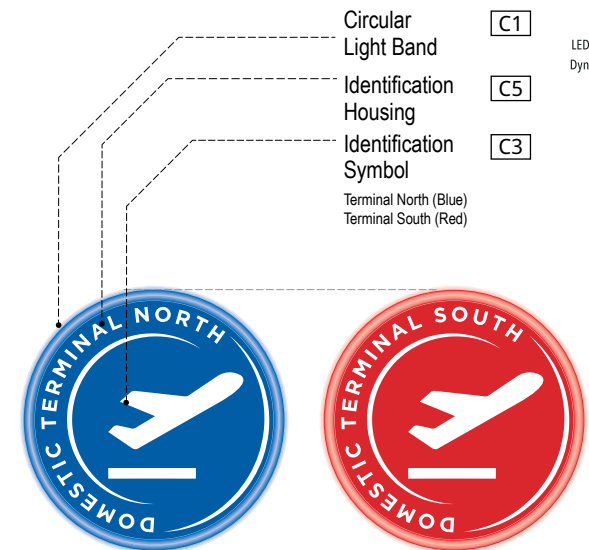

3 SIGN FINISHES - ICON
SCALE: NTS

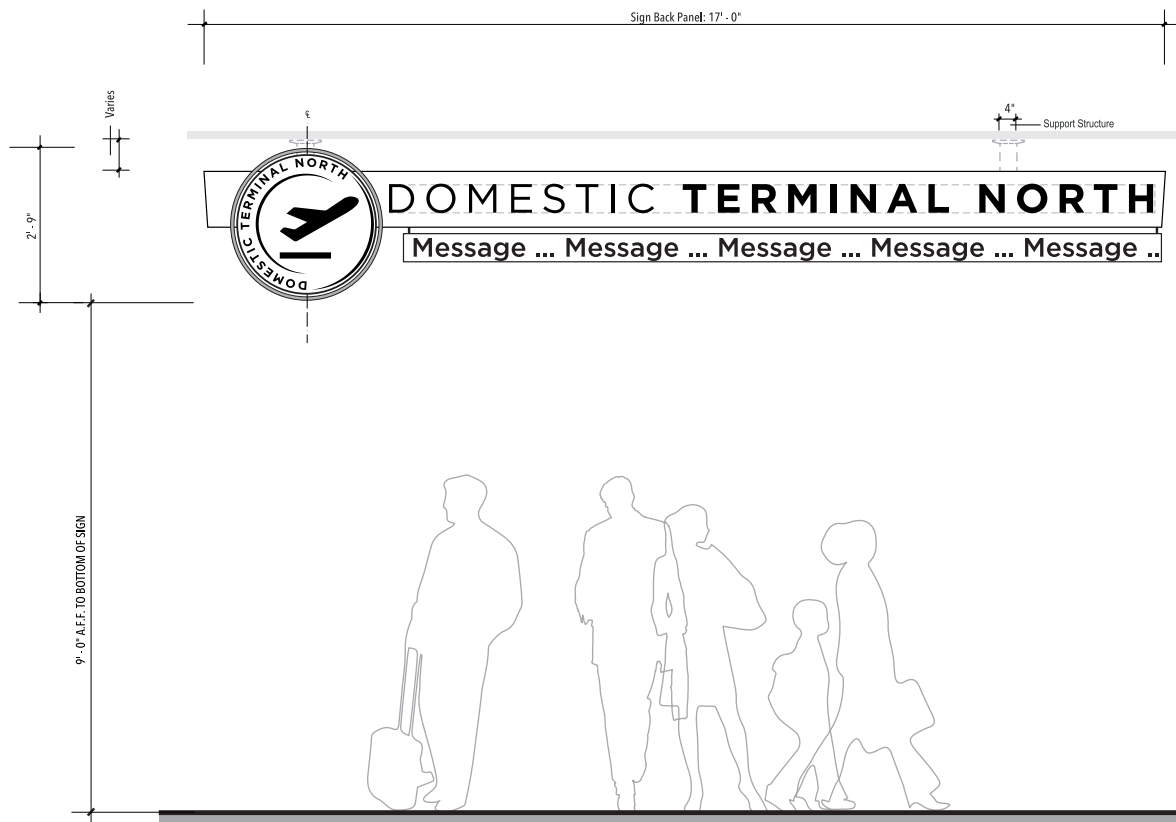

5 ELEVATION
SCALE: 1/2" = 1'-0"

Identification ST-542

- Descriptions:** Primary Identification
- Dimensions:** 2' - 9" High x 17' - 0" Wide x 12" Deep
Dynamic Display Bar: 6" H x 14' - 4" W x 4" D
- Location:** Ground Transportation
- Material:** Seamless fabricated aluminum sign panel
- Lettering:** Gotham Book and Medium
- Symbology:** Refer to Section 1 - Graphics Standards.
- Colors:**
- [C1]** Circular Light Band
 - 2" White acrylic (Exterior Sign Grade Translucent Polycarbonate)
 - LED Internally illuminated.
 - [C2]** Sign Support Structure
 - Seamless fabricated .125" ALUMINUM with all edges welded, grounded and sanded to a smooth finish.
 - [C3]** Identification Symbol
 - Fabricated dimensional letters White acrylic (Exterior Sign Grade Translucent Polycarbonate)
 - LED Internally illuminated.
 - [C4]** Message Text
 - Fabricated dimensional letters White acrylic (Exterior Sign Grade Translucent Polycarbonate)
 - LED Internally illuminated.
 - [C5]** Identification Housing
 - Seamless fabricated .125" ALUMINUM (satin brushed) with all edges welded, grounded and sanded to a smooth finish.
 - [C6]** Message Panel
 - Corresponding to assigned accent colors for:
 - Terminal North - Pantone 2935 (Blue)
 - Terminal South - Pantone 1795 (Red)
 - .25" Thick fabricated clear acrylic (Exterior Sign Grade Polycarbonate) overlaid matte Black vinyl.
 - [C7]** Reveal
 - ALUMINUM : Satin brushed
 - [C8]** Dynamic Display
 - Corresponding to assigned accent colors for:
 - Terminal North - Pantone 2935 (Blue)
 - Terminal South - Pantone 1795 (Red)
- Graphics:** N/A
- Mounting:** Ceiling Mounted
- Illuminations:** Internal
- Remarks:** Dynamic messages will vary per Owner's request

Notes:

1. Signs with directional messages to Terminal South will utilize "red" accent bar (Pantone 1795) only.
2. Signs with directional messages to Terminal North will utilize "blue" accent bar (Pantone 2935) only.
3. Colors are not interchangeable, and cannot be substituted.

2.0 SIGN TYPES

#	REVISION	DATE
1	Updated	07/25/17
2	Updated	10/13/17

2.4 Sign Type Layouts

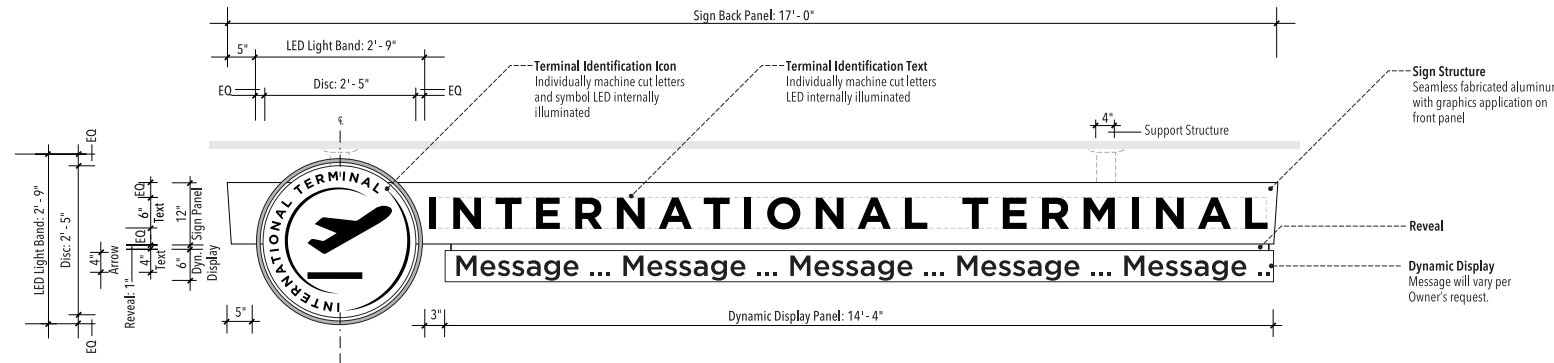

1 FACE LAYOUT - SIDE A
SCALE: 1/2" = 1'-0"

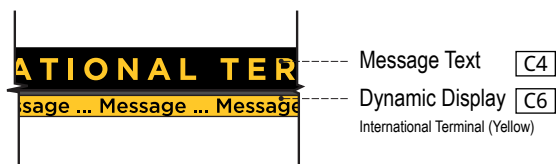

2 SIGN FINISHES
SCALE: NTS

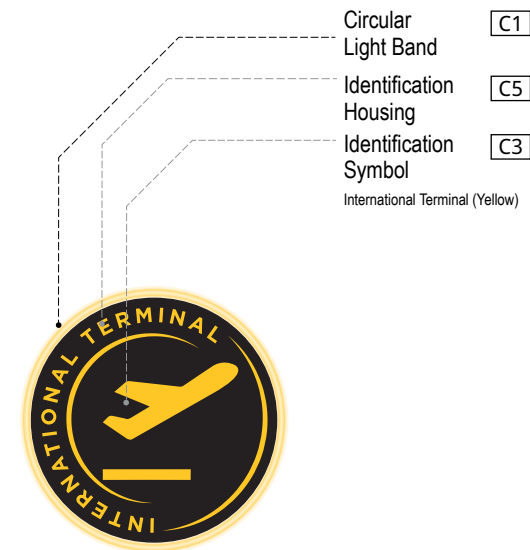

3 SIGN FINISHES - ICON
SCALE: NTS

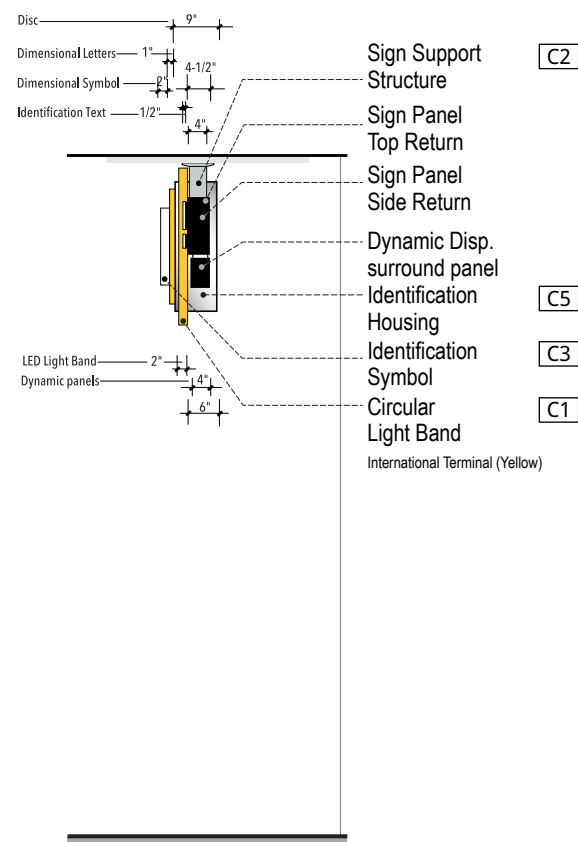

4 SIGN FINISHES - SIDE VIEW
SCALE: NTS



5 ELEVATION
SCALE: 1/2" = 1'-0"

Identification **ST-542**

- Descriptions:** Primary Identification
- Dimensions:** 2' - 9" High x 17' - 0" Wide x 12" Deep
Dynamic Display Bar: 6" H x 14' - 4" W x 4" D
- Location:** Ground Transportation
- Material:** Seamless fabricated aluminum sign panel
- Lettering:** Gotham Book and Medium
- Symbology:** Refer to Section 1 - Graphics Standards.
- Colors:**
- [C1] Circular Light Band
 - 2" White acrylic (Exterior Sign Grade Translucent Polycarbonate)
 - LED Internally illuminated.
 - [C2] Sign Support Structure
 - Seamless fabricated .125" ALUMINUM with all edges welded, grounded and sanded to a smooth finish.
 - [C3] Identification Symbol
 - Fabricated dimensional letters White acrylic (Exterior Sign Grade Translucent Polycarbonate)
 - LED Internally illuminated.
 - [C4] Message Text
 - Fabricated dimensional letters White acrylic (Exterior Sign Grade Translucent Polycarbonate)
 - LED Internally illuminated.
 - [C5] Identification Housing
 - Seamless fabricated .125" ALUMINUM (satin brushed) with all edges welded, grounded and sanded to a smooth finish.
 - [C6] Message Panel
 - Corresponding to assigned accent colors for:
International Terminal - Pantone 123 (Yellow)
 - .25" Thick fabricated clear acrylic (Exterior Sign Grade Polycarbonate) overlaid matte Black vinyl.
 - [C7] Reveal
 - ALUMINUM : Satin brushed
 - [C8] Dynamic Display
 - Corresponding to assigned accent colors for:
International Terminal - Pantone 123 (Yellow)
- Graphics:** N/A
- Mounting:** Ceiling Mounted
- Illuminations:** Internal
- Remarks:** Dynamic messages will vary per Owner's request

Notes:

- Signs with directional messages to International Terminal will utilize "yellow" accent bar (Pantone 123) only.
- Colors are not interchangeable, and cannot be substituted.

2.0 SIGN TYPES

#	REVISION	DATE
1	Updated	07/25/17
2	Updated	10/13/17

2.4 Sign Type Layouts

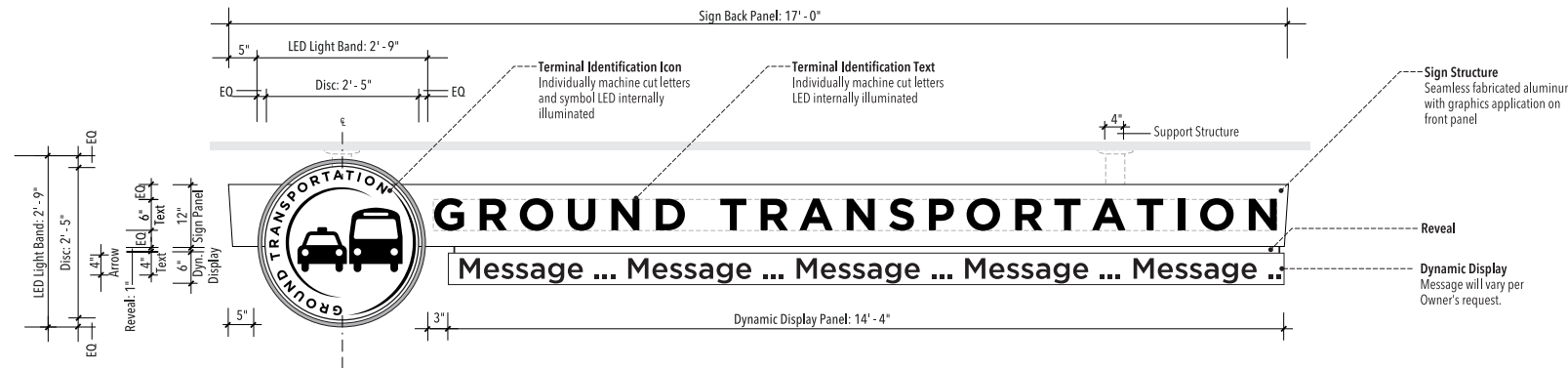

1 FACE LAYOUT - SIDE A
SCALE: 1/2" = 1'-0"

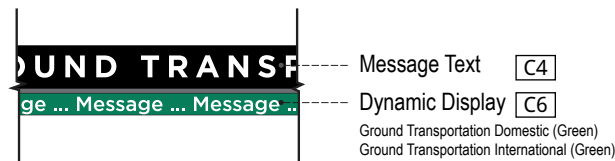

2 SIGN FINISHES
SCALE: NTS

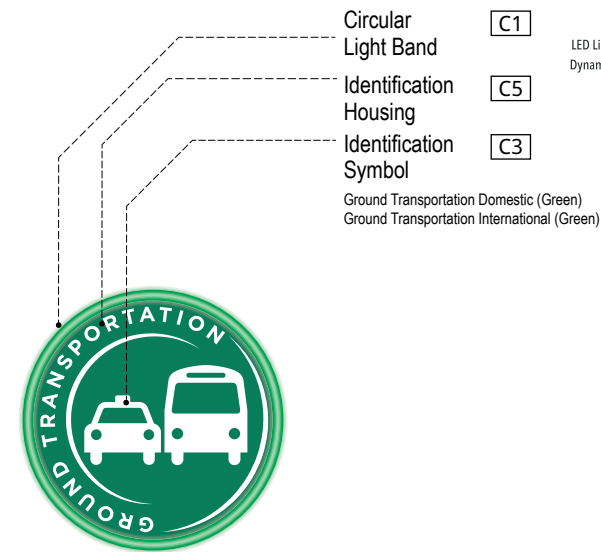

3 SIGN FINISHES - ICON
SCALE: NTS

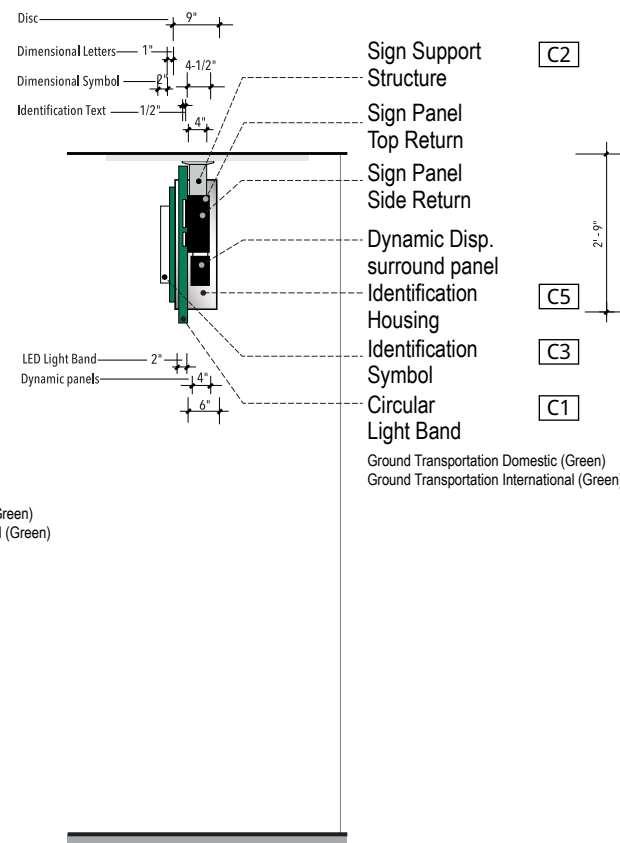

4 SIGN FINISHES - SIDE VIEW
SCALE: NTS

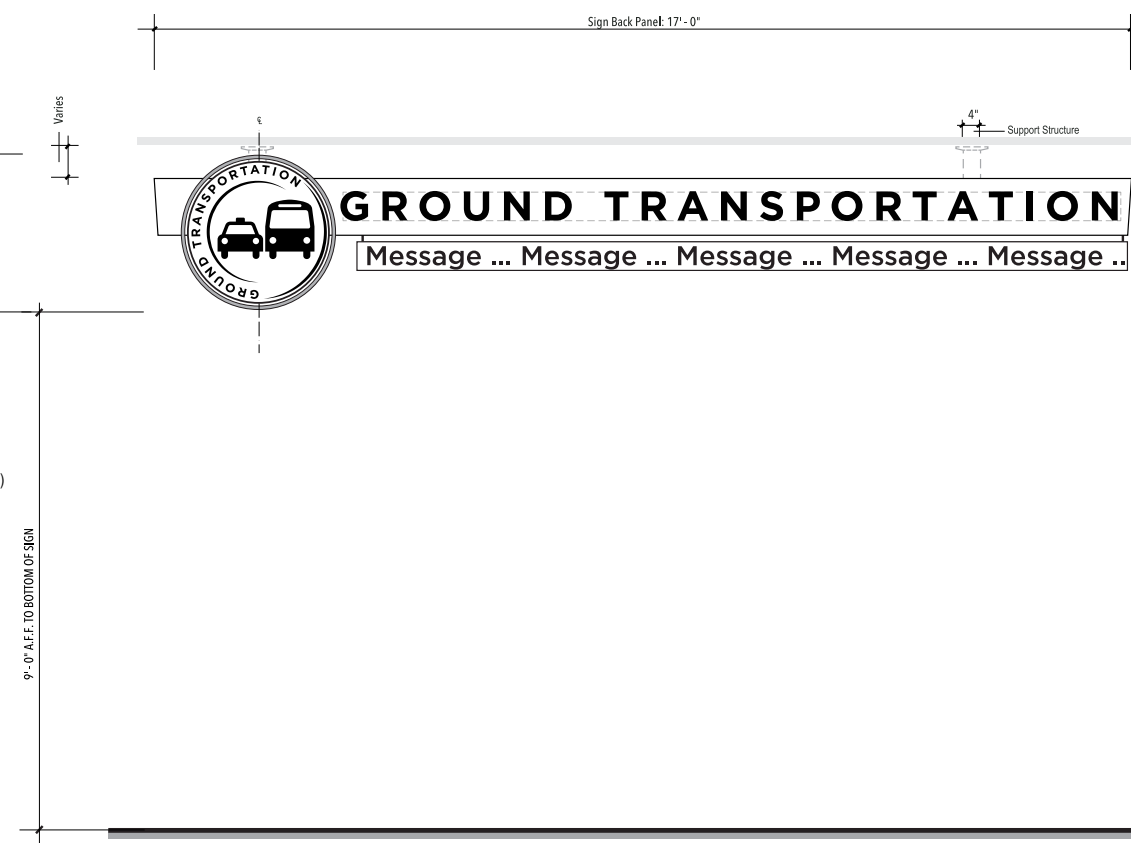

5 ELEVATION
SCALE: 1/2" = 1'-0"

Identification **ST-544**

- Descriptions:** Primary Identification
- Dimensions:** 2' - 9" High x 17' - 0" Wide x 12" Deep
Dynamic Display Bar: 6" H x 14' - 4" W x 4" D
- Location:** Ground Transportation
- Material:** Seamless fabricated aluminum sign panel
- Lettering:** Gotham Book and Medium
- Symbology:** Refer to Section 1 - Graphics Standards.
- Colors:**
- C1** • Circular Light Band
 - 2" White acrylic (Exterior Sign Grade Translucent Polycarbonate)
 - LED Internally illuminated.
 - C2** • Sign Support Structure
 - Seamless fabricated .125" ALUMINUM with all edges welded, grounded and sanded to a smooth finish.
 - C3** • Identification Symbol
 - Fabricated dimensional letters White acrylic (Exterior Sign Grade Translucent Polycarbonate)
 - LED Internally illuminated.
 - C4** • Message Text
 - Fabricated dimensional letters White acrylic (Exterior Sign Grade Translucent Polycarbonate)
 - LED Internally illuminated.
 - C5** • Identification Housing
 - Seamless fabricated .125" ALUMINUM (satin brushed) with all edges welded, grounded and sanded to a smooth finish.
 - C6** • Message Panel
 - Corresponding to assigned accent colors for:
 - Ground Transportation (Domestic) - Pantone 3415 C (Green)
 - Ground Transportation (International) - Pantone 3415 C (Green)
 - .25" Thick fabricated clear acrylic (Exterior Sign Grade Polycarbonate) overlaid matte Black vinyl.
 - C7** • Reveal
 - ALUMINUM : Satin brushed
 - C8** • Dynamic Display
 - Corresponding to assigned accent colors for:
 - Ground Transportation (Domestic) - Pantone 3415 C (Green)
 - Ground Transportation (International) - Pantone 3415 C (Green)

Graphics: N/A
Mounting: Ceiling Mounted
Illuminations: Internal
Remarks: Dynamic messages will vary per Owner's request

Notes:

- Signs with identification messages for Ground Transportation (Domestic) will utilize "green" accent color (Pantone 3415 C) only.
- Signs with identification messages for Ground Transportation (International) will utilize "green" accent color (Pantone 3415 C) only.
- Colors are not interchangeable, and cannot be substituted.

2.0 SIGN TYPES

#	REVISION	DATE
1	Updated	07/25/17
2	Updated	10/13/17

2.4 Sign Type Layouts

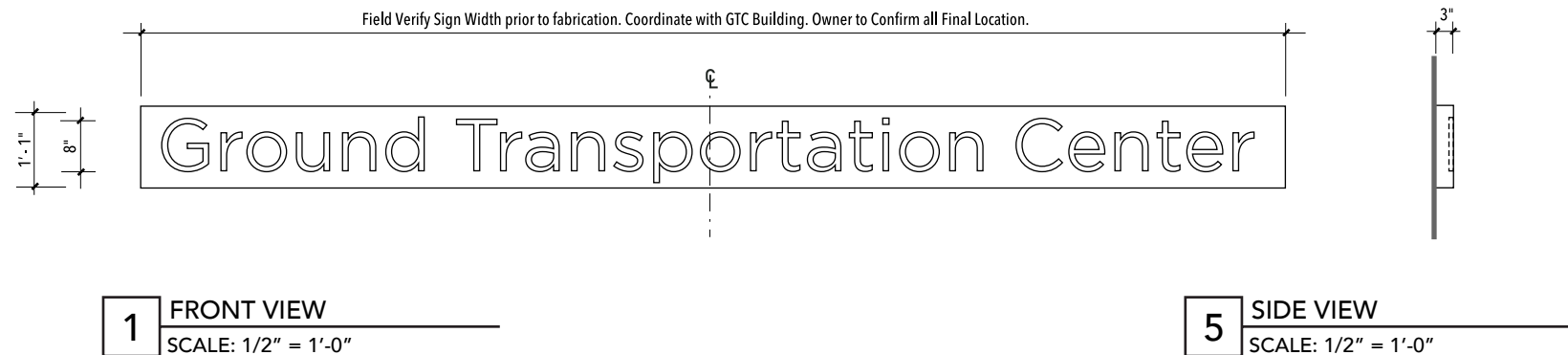

1 FRONT VIEW
SCALE: 1/2" = 1'-0"

5 SIDE VIEW
SCALE: 1/2" = 1'-0"

Identification ST-550

- Descriptions:** Secondary Identification
- Dimensions:** 1'-1" High x Field Verify Sign Width x 3" Deep
- Location:** Ground Transportation
- Material:** Seamless fabricated aluminum sign panel
- Lettering:** Gotham Book
- Symbology:** Refer to Section 1 - Graphics Standards.
- Colors:**
 - C1** • Sign Background Panel:
 - .250" Thick Satin Brushed Aluminum.
 - C2** • Building Identification
 - Individual machine cut letters.
 - LED Internally Illuminated.
- Graphics:** N/A
- Mounting:** Soffit Mounted
- Illuminations:** Internal
- Remarks:**



2 FINISH - FRONT VIEW - BUILDING FRONT
SCALE: NTS

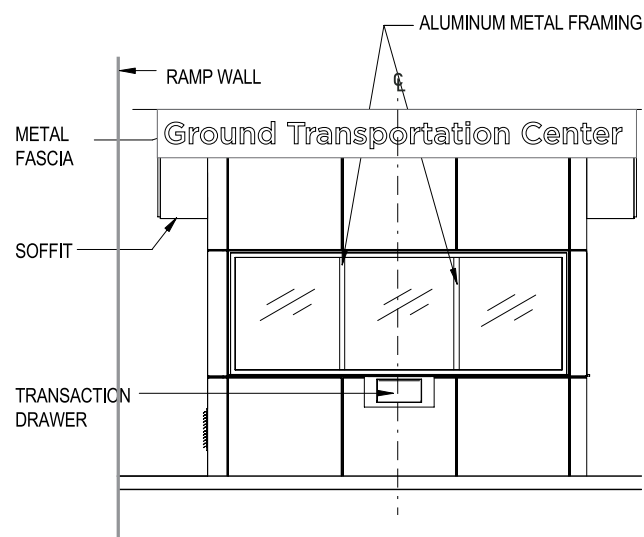

4 ELEVATION - BUILDING FRONT
SCALE: NTS

- Notes:
1. Field verify all conditions / dimensions.
 2. Sign to be field located
 3. Building by others.

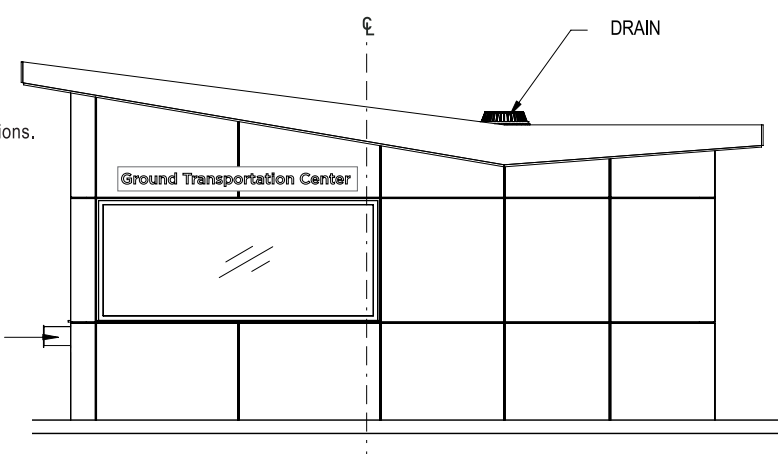

6 ELEVATION - WEST SIDE (ALTERNATE)
SCALE: NTS



3 FINISH - SIDE VIEW
SCALE: NTS

2.0 SIGN TYPES

#	REVISION	DATE
1	Updated	07/25/17
2	Updated	10/13/17



2 FINISH - TOP VIEW
SCALE: NTS

2.4 Sign Type Layouts

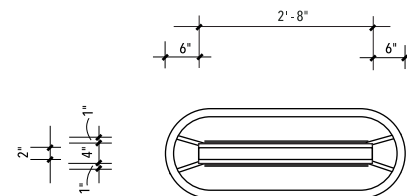

1 TOP VIEW
SCALE: 1/2" = 1'-0"

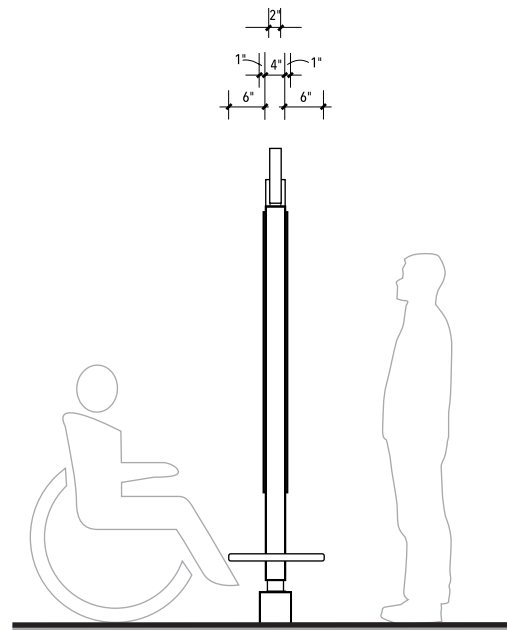

6 SIDE VIEW
SCALE: 1/2" = 1'-0"

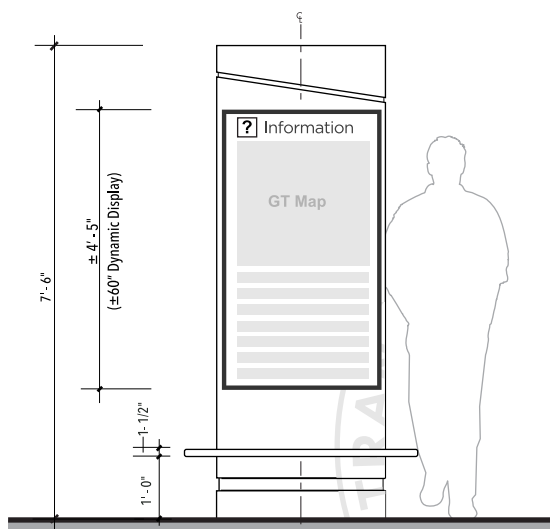
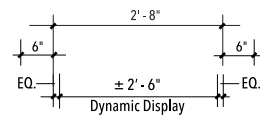

5 FACE LAYOUT - SIDE A
SCALE: 1/2" = 1'-0"

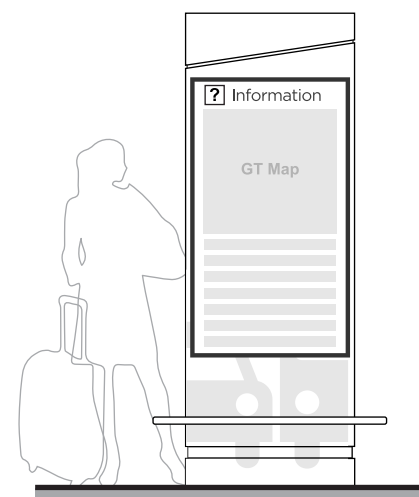

5 FACE LAYOUT - SIDE B
SCALE: 1/2" = 1'-0"

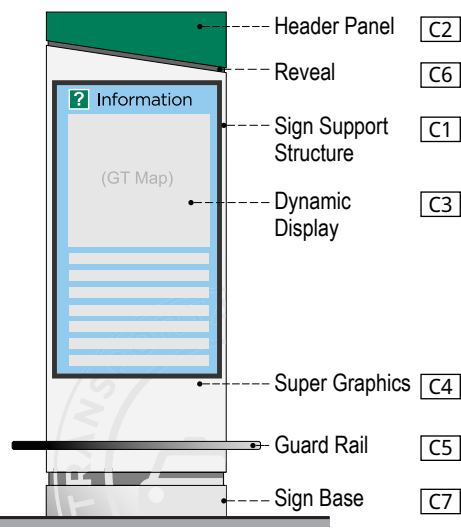

3 FINISH - FRONT VIEW
SCALE: NTS

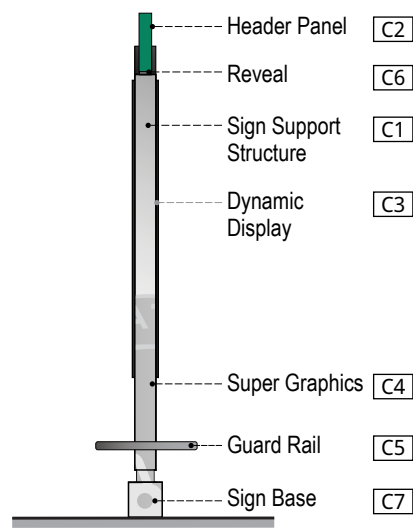

4 FINISH - SIDE VIEW
SCALE: NTS

Informational **ST-560**

- Descriptions:** Primary Informational - 2 sided
- Dimensions:** 7' - 6" High x 2' - 8" Wide x 1' - 4" Deep
- Location:** Ground Transportation
- Material:** Seamless fabricated aluminum sign
- Lettering:** 1. English - Gotham Book
- Symbology:** Refer to Section 1 - Graphic Standards
- Colors:**
- [C1] Sign Support Structure
 - Seamless fabricated .040 thick satin brushed aluminum.
 - No exposed fasteners.
 - [C2] Header Panel
 - .125" thick seamless fabricated acrylic corresponding to assigned accent colors for: Ground Transportation - Pantone 3415 C (Green)
 - LED Internally illuminated.
 - [C3] Dynamic Display
 - 60" Screen Monitor. To Be Reviewed / Approved by Owner.
 - [C4] Super Graphics
 - Exterior grade metallic vinyl application.
 - [C5] Guard Rail
 - Fabricated aluminum match sign structure finish.
 - Non-illuminated.
 - [C6] Reveal - Header and Base
 - Satin brushed aluminum.
 - [C7] Sign Base
 - Seamless fabricated aluminum structure.
 - Non-illuminated.

Graphics: N/A
Mounting: Freestanding
Illuminations: Internal
Remarks:

Notes:
 1. Signs with informational messages for Ground Transportation will utilize "green" accent color (Pantone 3415 C) only.
 2. Colors are not interchangeable, and cannot be substituted.

2.0 SIGN TYPES

#	REVISION	DATE
1	Updated	07/25/17
2	Updated	10/13/17

2.4 Sign Type Layouts

Stall Identification (Letter / Numbers)
Dimensional numbers
internally LED illuminated

Sign Structure
Seamless fabricated sign
structure internally
LED illuminated

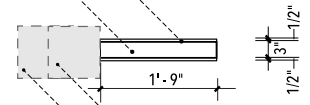

1 TOP VIEW
SCALE: 1/2" = 1' - 0"

Sign Attachment to Canopy Structure
Sign attachment method to be engineered
by sign fabricator. Field verify canopy
structure prior to final sign fabrication /
installation.

Sign Attachment to Canopy Structure
Sign attachment method to be engineered
by sign fabricator. Field verify canopy
structure prior to final sign fabrication /
installation.

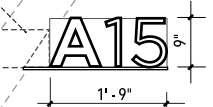

4 FRONT VIEW
SCALE: 1/2" = 1' - 0"

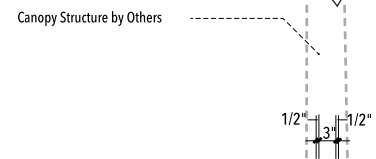

5 SIDE VIEW
SCALE: 1/2" = 1' - 0"

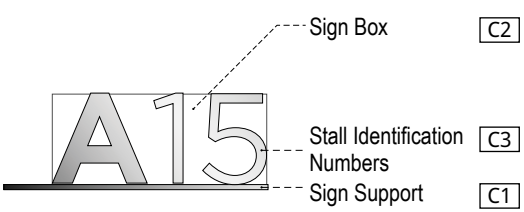

2 FINISH - FRONT VIEW
SCALE: NTS

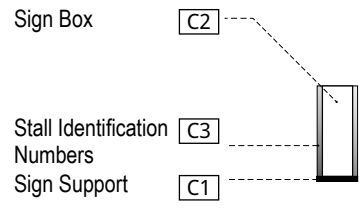

3 FINISH - END VIEW
SCALE: NTS

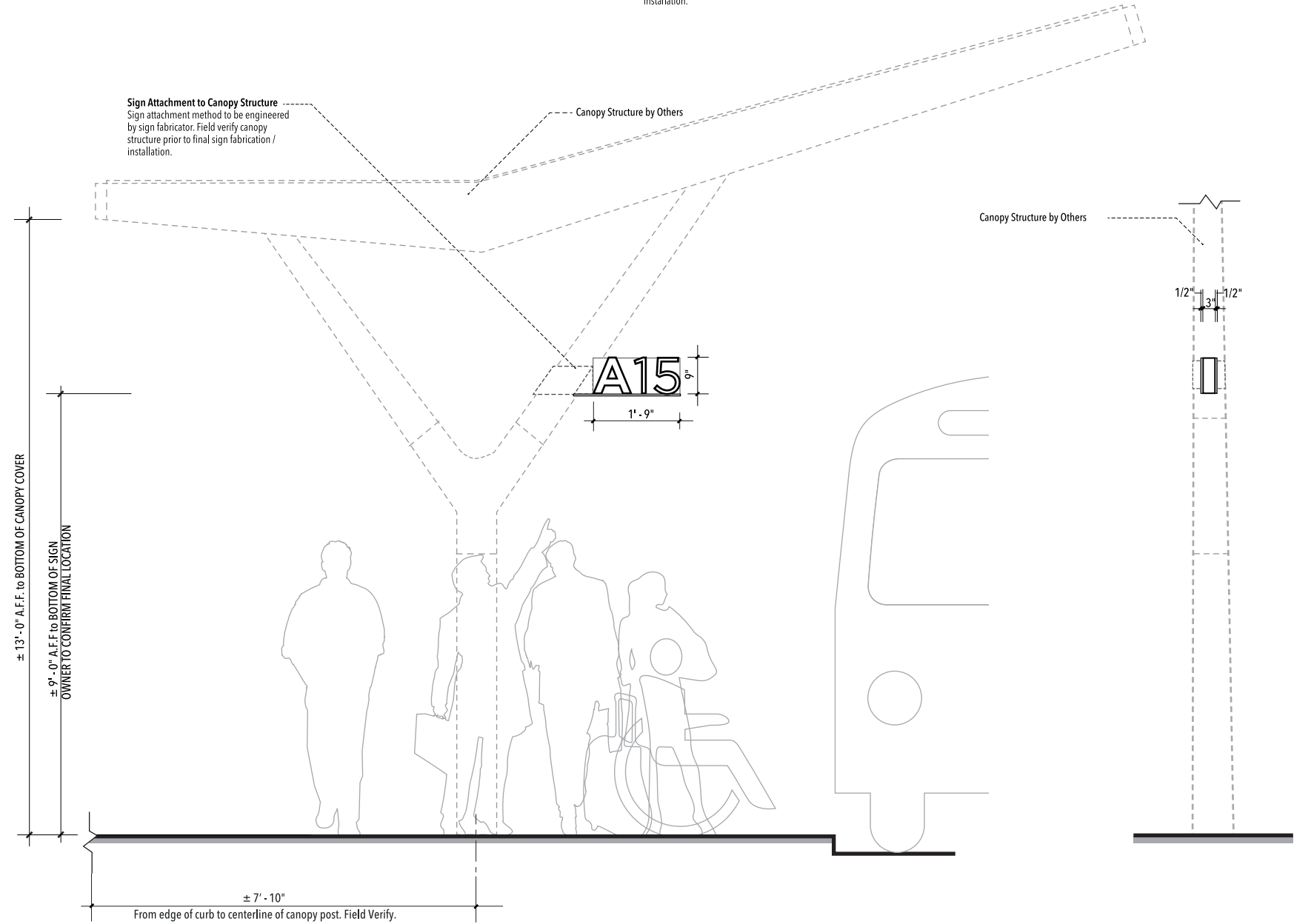

Informational **ST-570**

- Descriptions:** Secondary Informational - 2 sided
- Dimensions:** 9" High x 1'-9" Wide x 3" Deep
- Location:** Ground Transportation
- Material:** Seamless fabricated aluminum sign
- Lettering:** 1. English - Gotham Bold / Book
- Symbology:** Refer to Section 1 - Graphic Standards
- Colors:**
- C1 Sign Structure
 - Seamless fabricated sign structure.
 - LED internally illuminated.
 - C2 Sign Box
 - Seamless fabricated sign structure.
 - LED internally illuminated.
 - C3 Stall Identification Numbers
 - Individual machine cut dimensional numbers.
 - LED internally illuminated.
- Graphics:** N/A
- Mounting:** Flag Mounted
- Illuminations:** Internal
- Remarks:**

2.0 SIGN TYPES

#	REVISION	DATE
1	Updated	07/25/17
2	Updated	10/13/17

2.4 Sign Type Layouts

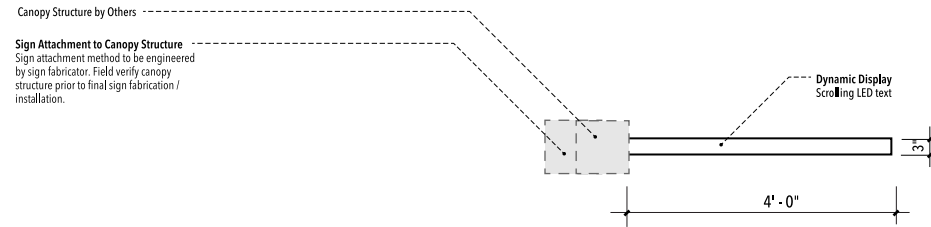

1 TOP VIEW
SCALE: 1/2" = 1'- 0"

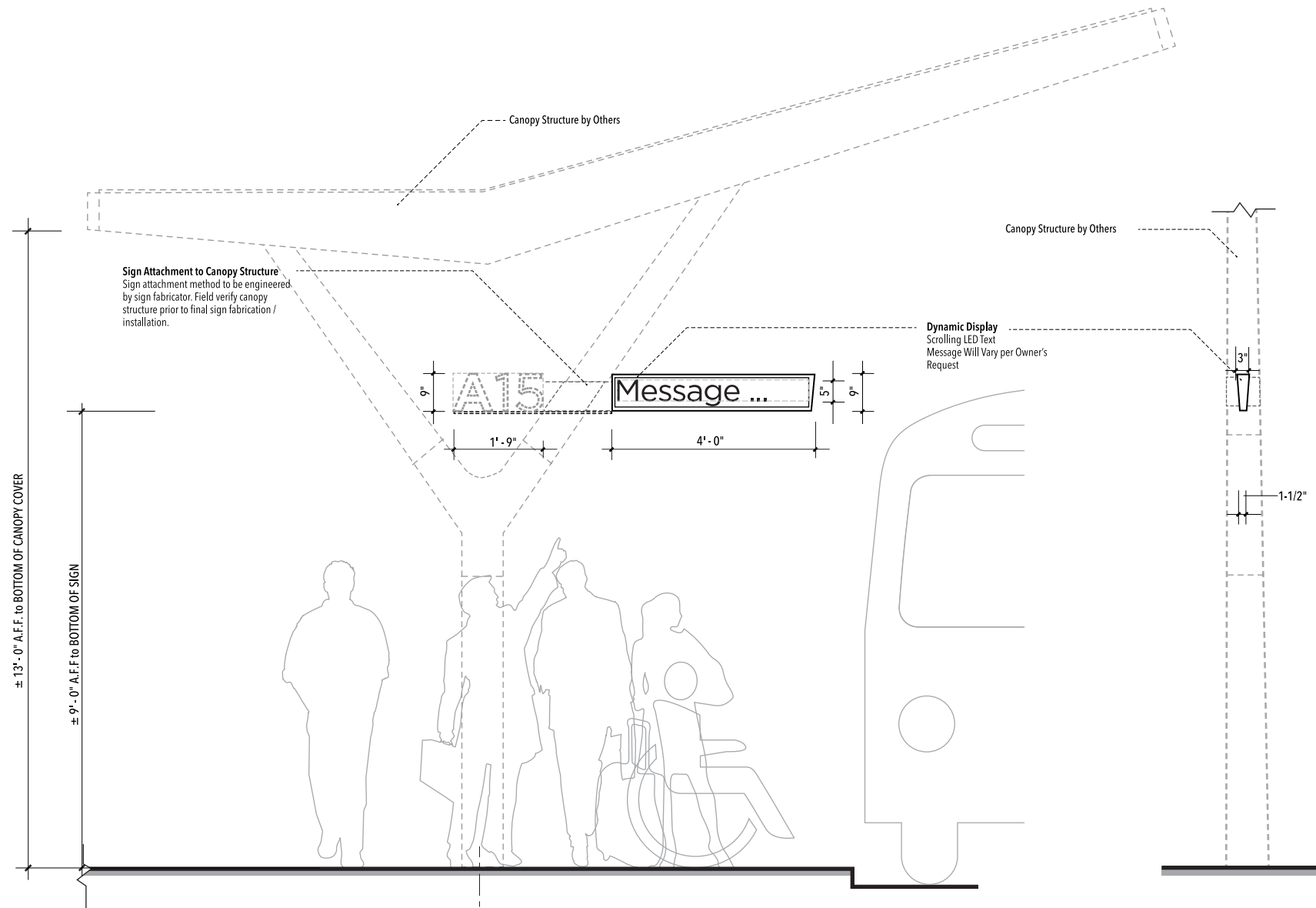

3 FRONT VIEW
SCALE: 1/2" = 1'- 0"

4 SIDE VIEW
SCALE: 1/2" = 1'- 0"

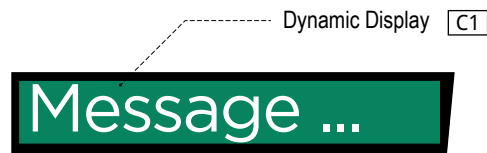

2 FRONT VIEW
SCALE: NTS

Informational **ST-572**

- Descriptions:** Secondary Informational - 2 sided
- Dimensions:** 9" High x 4'-0" Wide x 3" Deep
- Location:** Ground Transportation
- Material:** Seamless fabricated aluminum sign
- Lettering:** 1. English - Gotham Book
- Symbology:** Refer to Section 1 - Graphic Standards
- Colors:** C1 Dynamic Display - Nanolumens NanoSlim or Approved equal.
- Graphics:** N/A
- Mounting:** Flag Mounted
- Illuminations:** Internal
- Remarks:**

Notes:
 1. Signs with informational messages for Ground Transportation will utilize "green" accent color (Pantone 3415 C) only.
 2. Colors are not interchangeable, and cannot be substituted.

2.0 SIGN TYPES

#	REVISION	DATE
1	Updated	07/25/17
2	Updated	10/13/17

2.4 Sign Type Layouts

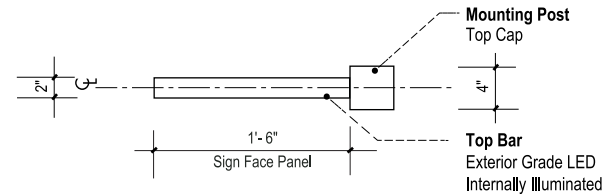

1 TOP VIEW - SIDE A
SCALE: 1" = 1'-0"

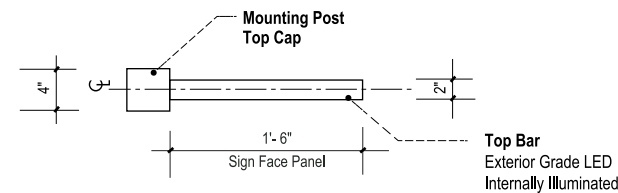

6 TOP VIEW - SIDE B
SCALE: 1" = 1'-0"

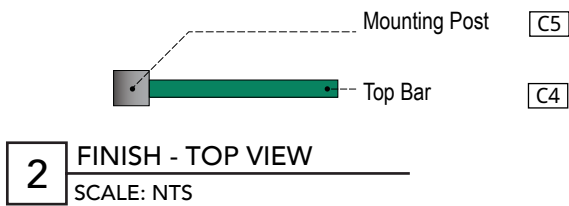

2 FINISH - TOP VIEW
SCALE: NTS

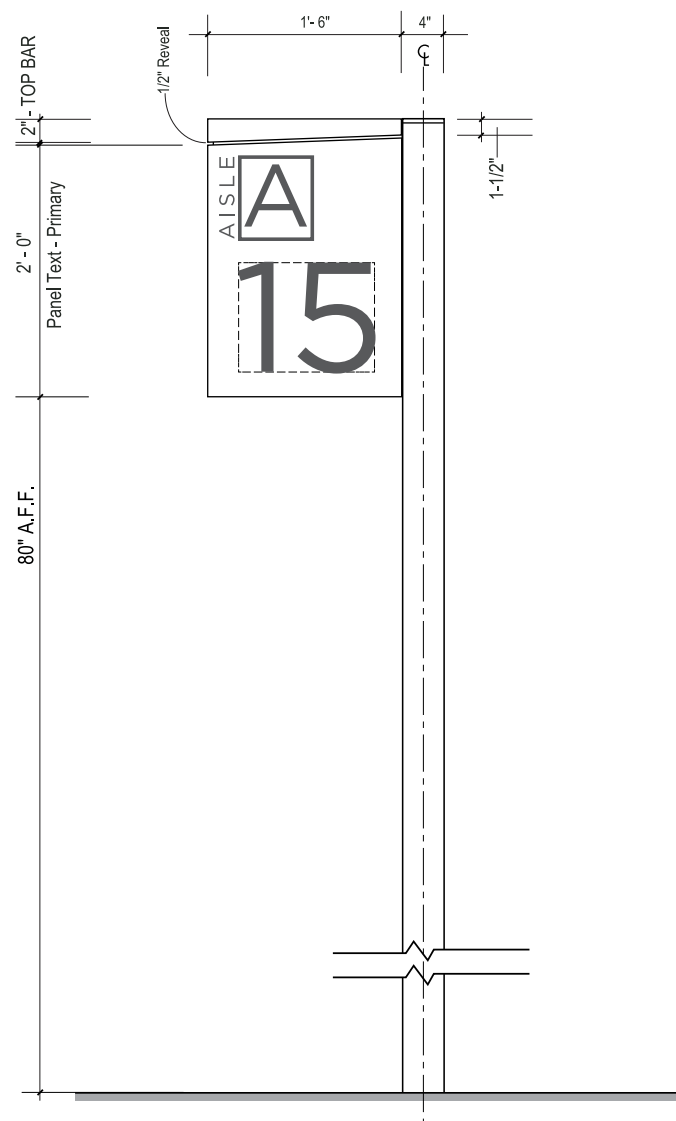

5 FRONT VIEW - SIDE A
SCALE: 1" = 1'-0"

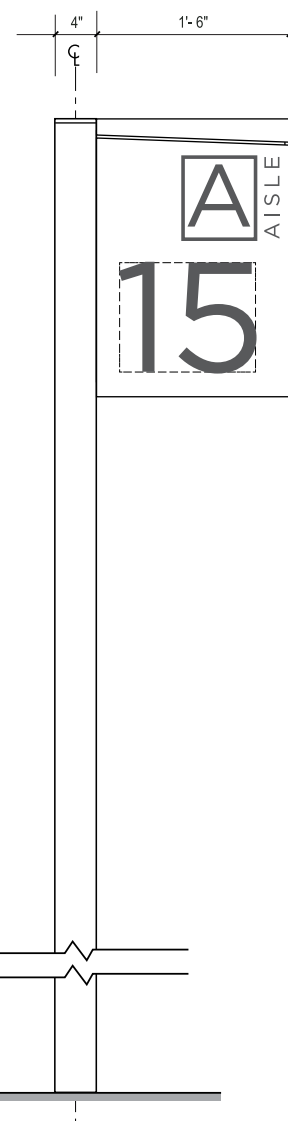

7 FRONT VIEW - SIDE B
SCALE: 1" = 1'-0"

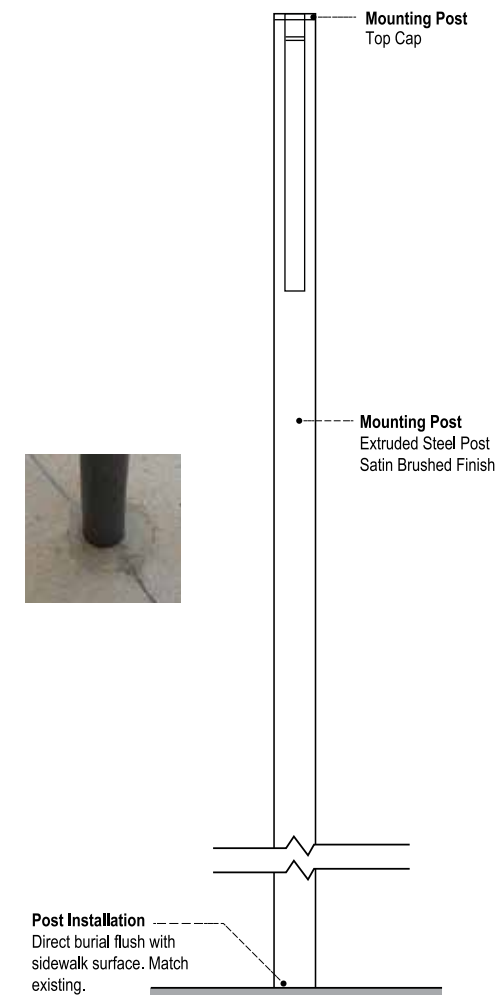

8 END VIEW
SCALE: 1" = 1'-0"

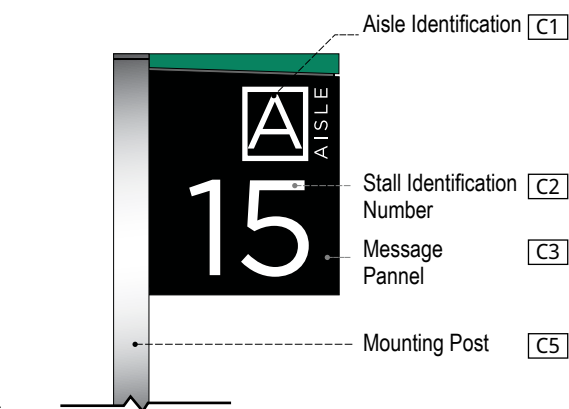

3 FINISH - FRONT VIEW
SCALE: NTS

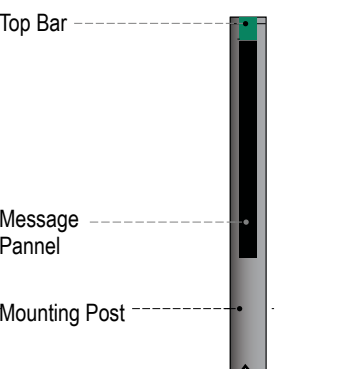

4 FINISH - END VIEW
SCALE: NTS

Informational ST-574

- Descriptions:** Secondary Informational - 2 sided
- Dimensions:** 2'-0" High x 1'-6" Wide x 2" Deep
- Location:** Ground Transportation
- Material:** Seamless fabricated aluminum sign
- Lettering:** 1. English - Gotham Book
- Symbology:** Refer to Section 1 - Graphic Standards
- Colors:**
 - C1 Aisle Identification
 - Electronically cut out overlay.
 - LED Internally illuminated.
 - C2 Stall Identification Number
 - Electronically cut out overlay.
 - LED Internally illuminated.
 - C3 Message Panel
 - .25" Thick fabricated clear acrylic (Exterior Sign Grade Polycarbonate) overlaid matte Black vinyl.
 - C4 Top Bar
 - .25" thick seamless fabricated (Translucent Exterior Sign Grade Polycarbonate acrylic corresponding to assigned accent colors for: Ground Transportation - Pantone 3415 C (Green) - LED Internally Illuminated.
 - C5 Mounting Post
 - Extruded Steel Post.
 - Satin Brushed Finish.

Graphics: N/A
Mounting: Post / Flag Mounted
Illuminations: Internal
Remarks:

Notes:
 1. Signs with informational messages for Ground Transportation will utilize "green" accent color (Pantone 3415 C) only.
 2. Colors are not interchangeable, and cannot be substituted.

2.0 SIGN TYPES

#	REVISION	DATE
1	Updated	07/25/17
2	Updated	10/13/17

2.4 Sign Type Layouts

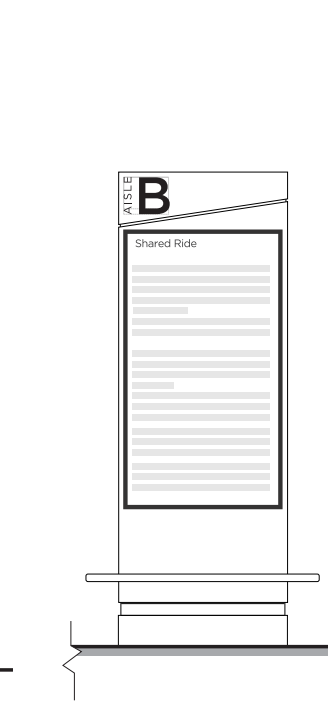
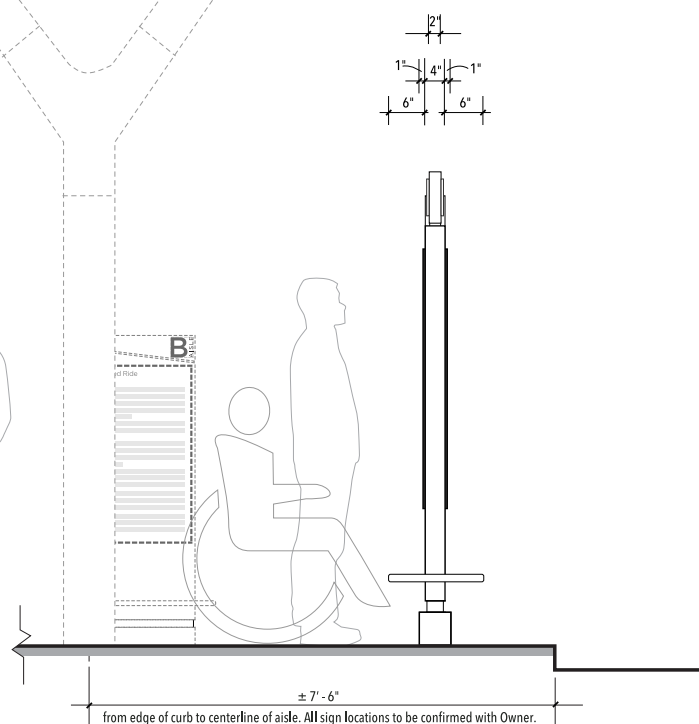
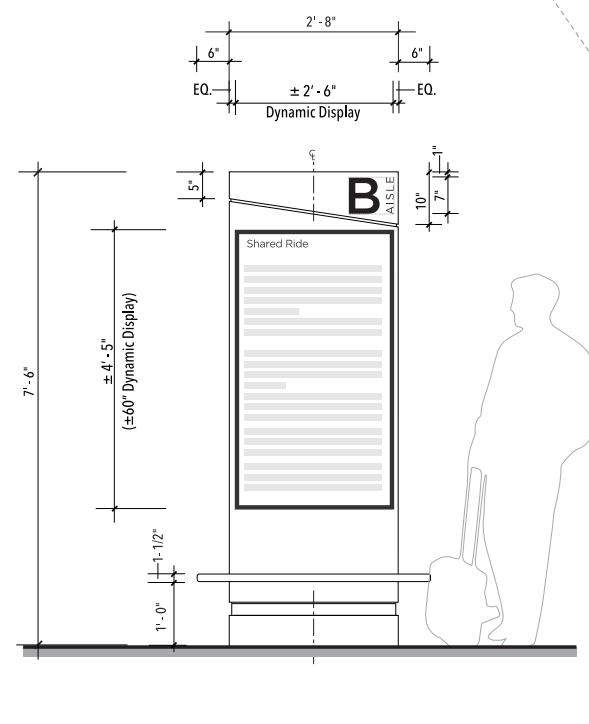
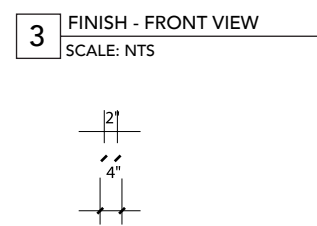
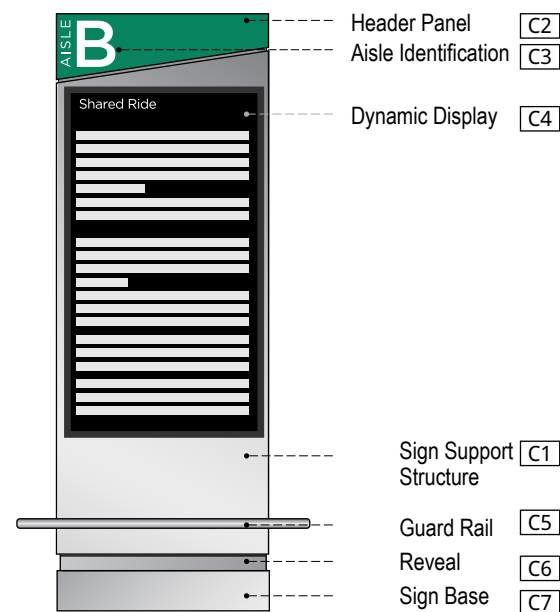
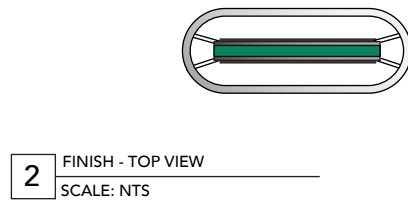
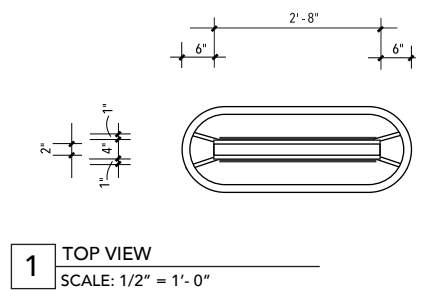

Informational **ST-576**

- Descriptions:** Secondary Informational - 2 sided
- Dimensions:** 7' - 6" High x 2' - 8" Wide x 1' - 4" Deep
- Location:** Ground Transportation
- Material:** Seamless fabricated aluminum sign
- Lettering:** 1. English - Gotham Medium / Book
- Symbology:** N/A
- Colors:**
- [C1] Sign Support Structure
 - Seamless fabricated .040 thick satin brushed aluminum.
 - No exposed fasteners.
 - [C2] Header Panel
 - .125" thick seamless fabricated acrylic corresponding to assigned accent colors for: Ground Transportation - Pantone 3415 C (Green)
 - LED Internally illuminated.
 - [C3] Aisle Identification
 - Fabricated machine cut dimensional graphics.
 - LED internally illuminated.
 - [C4] Dynamic Display
 - 60" Screen Monitor. To Be Reviewed / Approved by Owner.
 - [C5] Guard Rail
 - Fabricated aluminum match sign structure finish.
 - Non-illuminated.
 - [C6] Reveal - Header and Base
 - Satin brushed aluminum.
 - [C7] Sign Base
 - Seamless fabricated aluminum structure.
 - Non-illuminated.

Graphics: N/A
Mounting: Freestanding
Illuminations: Internal
Remarks:

Notes:

1. Signs with informational messages for Ground Transportation will utilize "green" accent color (Pantone 3415 C) only.
2. Colors are not interchangeable, and cannot be substituted.



 Hartsfield-Jackson
Atlanta International Airport®

Prepared by:  AIS |  VALANCOURT
INTERNATIONAL LLC